

Order code: 001-4-020-3-B1STF-XT0

1) IC-SOCKETS, STRIPS, CARRIERS

Series: **001**

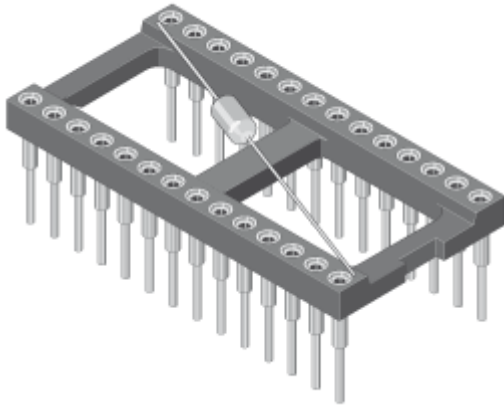

IC-sockets with machined contacts in all common pin counts and row spacing's. Available with decoupling capacitor.

Socket with centre bar. and with decoupling capacitor. The standard value of the capacitor is 100 nF.

Gender	Female
Pitch (mm)	2,54
Mating pin size (range)	ø 0,40-0,56, sq. 0,25x0,45
No of contacts	20
Row distance (code)	300 mil
Contact type	B1 - Standard B

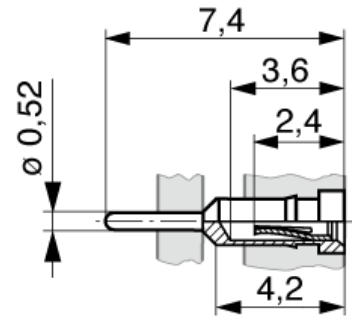

Material contact	Copper alloy
Material clip	Beryllium copper
Plating contact	Sn
Plating clip	Au
Insulator Style	With Bar
Material insulator	High temp. thermoplast UL94V-0
Rated current	3,0 A
Rated voltage	150 VRMS / VDC
Withstand voltage	1000 VRMS for 1 minute
Operating temperature	-55°C to +125°C
Max. processing temper.	260°C for 10 seconds
Packaging	Tube
Cap	Without cap
D (Row dist. mm)	7,62
A	25,30
B	10,10
C	4,40

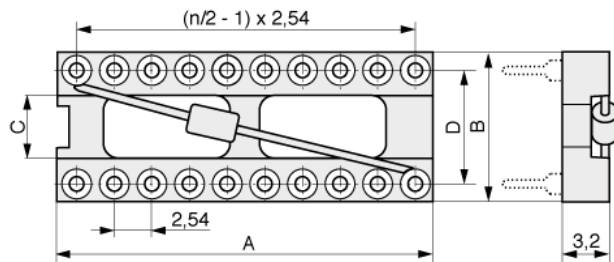

Order code: 001-4-020-3-B1STF-XT0



MPE Garry GmbH
Schäfflerstraße 13
87629 Füssen/Germany

Phone: +49 (0) 83 62 / 91 56-0
Fax: +49 (0) 83 62 / 91 56-500
Email: vk@mpe-connector.de

Date: 16.03.2016 Internet: http://www.mpe-connector.de/index.php?lang=en&menu=16&s_product=001-4-020-3-B1STF-XT0