

HSMD-Cxxx, HSMG-Cxxx, HSMH-Cxxx, HSMS-Cxxx, HSMY-Cxxx

Surface Mount ChipLEDs

HSMx-C110/HSMx-C120/HSMx-C150/HSMx-C170/HSMx-C177/
HSMx-C190/HSMx-C191/HSMx-C197/HSMx-C265

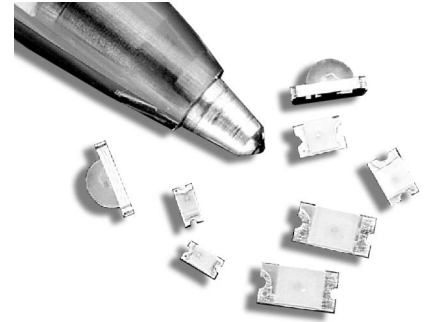

Description

These chipLEDs are designed in an industry-standard package for ease of handling and use. Various LED colors are available in nine compact, single-color packages.

The HSMx-C150 has the industry-standard 3.2 mm × 1.6 mm footprint, which is excellent for all-around use. The HSMx-C170 has the widely used 2.0 mm × 1.25 mm footprint with a 0.8-mm profile. The HSMx-C177 has the widely used 2.0 mm × 1.25 mm footprint with a 0.4-mm profile. The HSMx-C19x series has the industry-standard 1.6 mm × 0.8 mm footprint with a varying profile to suit designers needs: the HSMx-C190 has a 0.8-mm profile, the HSMx-C191 has a low profile of 0.6 mm, and the HSMx-C197 has an ultra-low profile of 0.4 mm. This family with its thin profile and wide viewing angle makes this LED exceptional for backlighting applications.

The HSMx-C110 is a right angle package with the universally accepted dimensions of 3.2 × 1.0 × 1.5 mm. The HSMx-C120 is a smaller right angle package with industry standard 1.6 × 0.6 × 1.0 mm. HSMx-C265 is a reverse mount package with dimensions of 3.4 × 1.25 × 1.1 mm. These devices are ideal for LCD backlighting and sidelighting applications.

To facilitate pick and place operation, these chipLEDs are shipped in tape and reel with 4000 units per reel for HSMx-C120, C170, C177, C190, C191, and C197 packages and with 3000 units per reel for HSMx-C110, C150, and C265 packages.

All packages are compatible with IR reflow solder processes. The small size and wide viewing angle make these LEDs prime choices for backlighting applications and front-panel illumination, especially where space is a premium.

Features

- Small size
- Industry-standard footprint
- Compatible with IR solder
- Diffused optics
- Operating temperature range of -40°C to +85°C
- Right angle and reverse mount package available
- Various colors available
- Available in 8-mm tape on 7-in. (178-mm) diameter reels

Applications

- Keypad backlighting
- Push-button backlighting
- LCD backlighting
- Symbol backlighting
- Front-panel indicator

Package Drawing

HSMx-C150

HSMx-C170

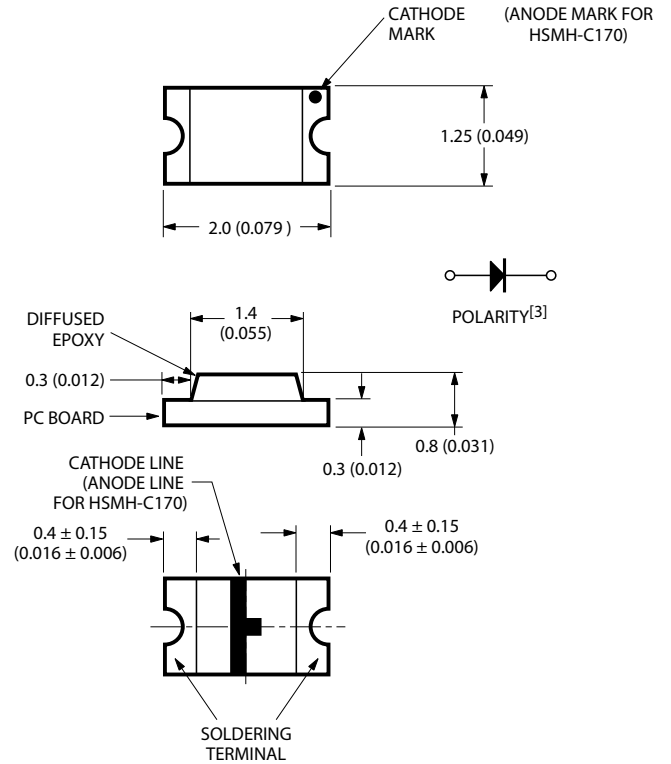
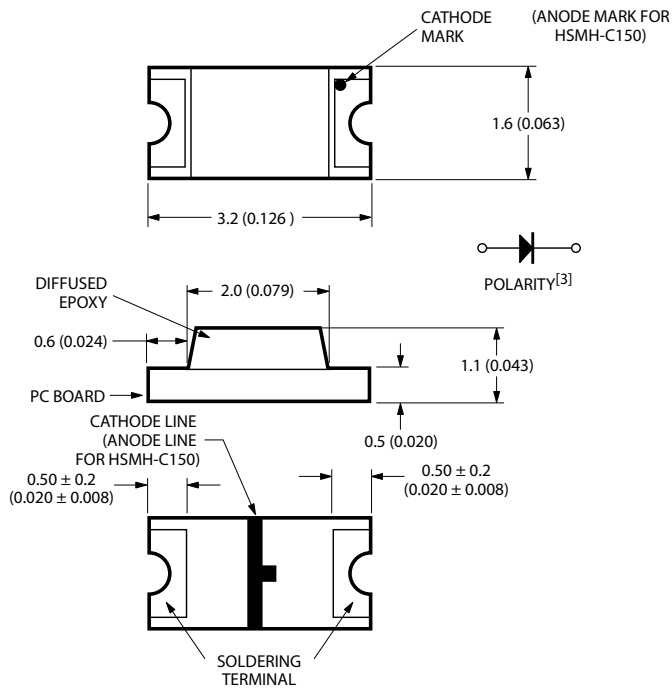

Notes:

1. All dimensions are in millimeters (inches).
2. Tolerance is ±0.1 mm (±0.004 in.) unless otherwise specified.
3. Polarity for HSMH-Cxxx will be the opposite of what is shown in the above drawings.

HSMx-C190

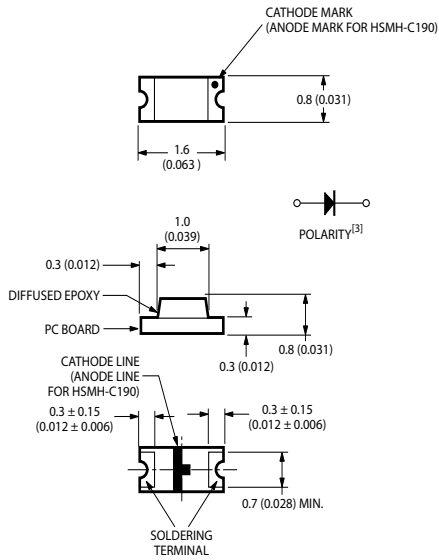

HSMx-C110

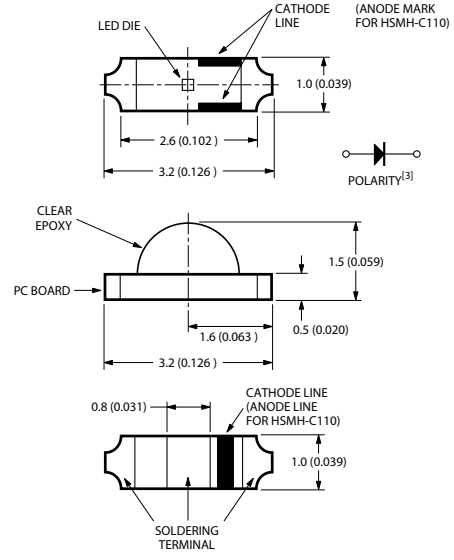

HSMx-C191

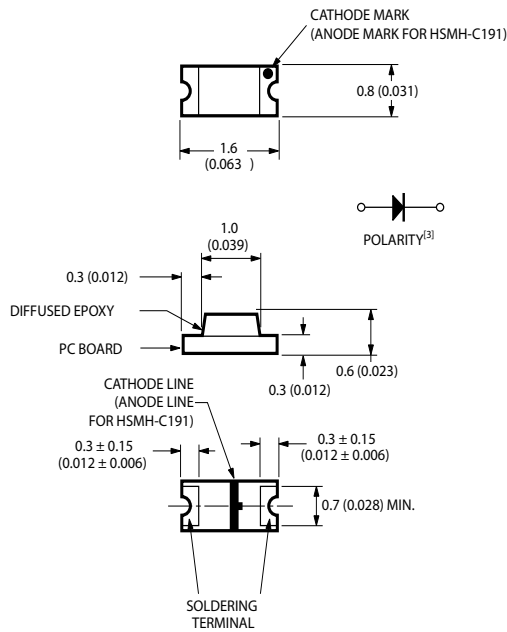

HSMx-C177

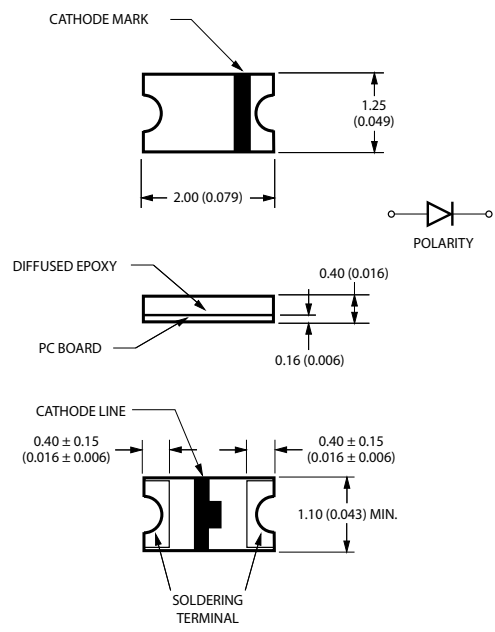

Notes:

1. All dimensions are in millimeters (inches).
2. Tolerance is ±0.1 mm (±0.004 in.) unless otherwise specified.
3. Polarity for HSMH-Cxxx will be the opposite of what is shown in the above drawings.

HSMx-C265

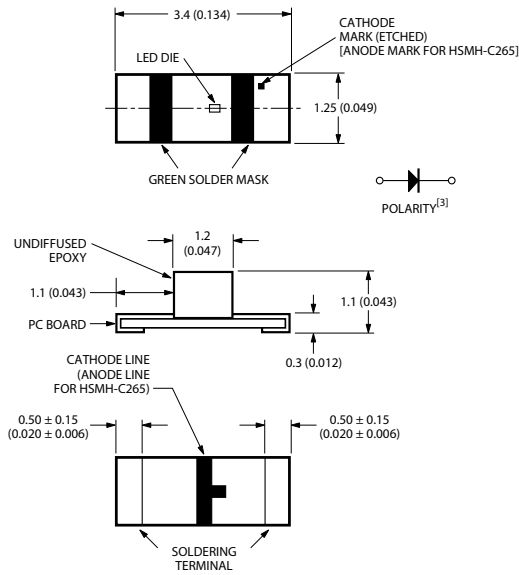

HSMx-C197

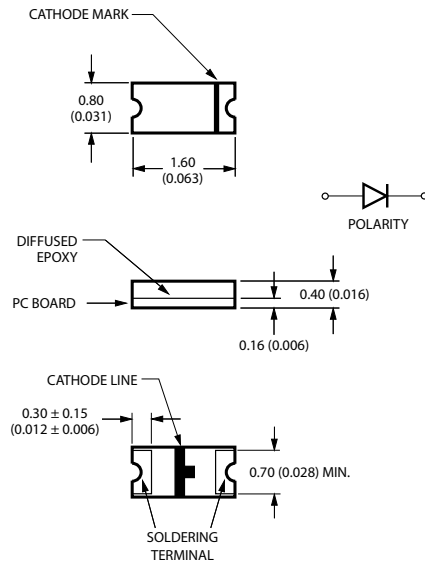

HSMx-C120

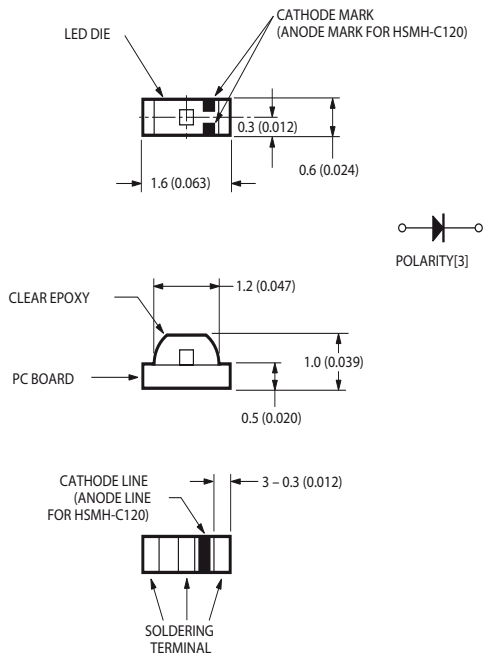

Notes:

1. All dimensions are in millimeters (inches).
2. Tolerance is ±0.1 mm (±0.004 in.) unless otherwise specified.
3. Polarity for HSMH-Cxxx will be the opposite of what is shown in the above drawings.

Device Selection Guide

Table 1: AlInGaP

Green	Red	Orange	Yellow	Description
HSMG-C110	HSMS-C110	HSMD-C110	HSMY-C110	Untinted, Non-Diffused
HSMG-C120	HSMS-C120	HSMD-C120	—	Untinted, Non-Diffused
HSMG-C150	HSMS-C150	HSMD-C150	HSMY-C150	Untinted, Diffused
HSMG-C170	HSMS-C170	HSMD-C170	HSMY-C170	Untinted, Diffused
HSMG-C177	HSMS-C177	HSMD-C177	HSMY-C177	Untinted, Diffused
HSMG-C190	HSMS-C190	HSMD-C190	HSMY-C190	Untinted, Diffused
HSMG-C191	HSMS-C191	HSMD-C191	HSMY-C191	Untinted, Diffused
HSMG-C197	HSMS-C197	HSMD-C197	HSMY-C197	Untinted, Diffused
HSMG-C265	—	—	—	Untinted, Non-Diffused

Table 2: As AlGaAs

Red	Description
HSMH-C110	Untinted, Non-Diffused
HSMH-C120	Untinted, Non-Diffused
HSMH-C150	Untinted, Diffused
HSMH-C170	Untinted, Diffused
HSMH-C190	Untinted, Diffused
HSMH-C191	Untinted, Diffused
HSMH-C265	Untinted, Non-Diffused

Absolute Maximum Ratings

Table 3: Absolute Maximum Ratings for AlInGaP at TA = 25°C

Parameter	C110/150/265	C120/170/177/190/191/197	Units
DC Forward Current ^a	25	20	mA
Power Dissipation	65	52	mW
Reverse Voltage (I _R =100 μA)	5	5	V
LED Junction Temperature	95	95	°C
Operating Temperature Range	-40 to +85	-40 to +85	°C
Storage Temperature Range	-40 to +85	-40 to +85	°C
Soldering Temperature	See reflow soldering profile (Figure 9 & Figure 10)		

a. Derate linearly as shown in Figure 4 for temperatures above 25°C.

Table 4: Absolute Maximum Ratings for AlGaAs at TA = 25°C

Parameter	C110/150	C120/170/190/191/265	Units
DC Forward Current ^a	30	25	mA
Power Dissipation	78	65	mW
Reverse Voltage (I _R =100 μA)	5	5	V
LED Junction Temperature	95	95	°C
Operating Temperature Range	-40 to +85	-40 to +85	°C
Storage Temperature Range	-40 to +85	-0 to +85	°C
Soldering Temperature	See reflow soldering profile (Figure 9 & Figure 10)		

a. Derate linearly as shown in Figure 4 for temperatures above 25°C.

Electrical Characteristics and Optical Characteristics

Table 5: Electrical Characteristics at TA = 25°C

Part Number	Color	Forward Voltage V _F (Volts) @ I _F = 20 mA			Reverse Breakdown V _R (Volts) @ I _R = 100 μA	Capacitance C(pF) @ V _F = 0V, f = 1 MHz	Thermal Resistance R _{θJ-P} (°C/W)
		Min.	Typ.	Max.	Min.	Typ.	Typ.
HSMS-C110/150	Red	1.6	2.1	2.6	5	5	400
HSMS-C120							350
HSMS-C170/177/190/191/197							250
HSMD-C110/150	Orange	1.6	2.2	2.6	5	7	400
HSMD-C120							350
HSMD-C170/177/190/191/197							250
HSMY-C110/150	Yellow	1.6	2.1	2.6	5	6	400
HSMY-C170/177/190/191/197							250
HSMG-C110/150	Green	1.6	2.2	2.6	5	9	400
HSMG-C120							350
HSMG-C170/177/190/191/197/265							250
HSMH-C110/150	AlGaAs	1.6	1.8	2.6	5	18	460
HSMH-C120							400
HSMH-C170/190/191/265							300

Table 6: Optical Characteristics at TA = 25°C

Part Number	Color	Luminous Intensity ^a I _v (mcd) @ 20 mA		Peak Wavelength λ _{peak} (nm)	Dominant Wavelength λ _d (nm)	Viewing Angle 2θ _{1/2} (°) ^b
		Min.	Typ.	Typ.	Typ.	Typ.
HSMG-C110/177/197	Green	4.5	15.0	570	572	130
HSMG-C120						155
HSMG-C150/170/190/191/265						170
HSMS-C110/177/197	Red	2.8	10.0	630	626	130
HSMS-C120						155
HSMS-C150/170/190/191						170
HSMD-C110/177/197	Orange	2.8	8.0	605	604	130
HSMD-C120						155
HSMD-C150/170/190/191						170
HSMY-C110/177/197	Yellow	2.8	8.0	589	586	130
HSMY-C150/170/190/191						170
HSMH-C110	AlGaAs	7.2	17.0	660	639	130
HSMH-C120						155
HSMH-C150/170/190/191/265						170

a. The luminous intensity, I_v, is measured at the peak of the spatial radiation pattern, which may not be aligned with the mechanical axis of the lamp package.

b. θ_{1/2} is the off-axis angle where the luminous intensity is 1/2 the peak intensity.

Color Bin Limits

Table 7: Green Color Bins^a

Bin ID	Dominant Wavelength (nm)	
	Min.	Max.
A	561.5	564.5
B	564.5	567.5
C	567.5	570.5
D	570.5	573.5
E	573.5	576.5

a. Tolerance: ± 1 nm

Table 9: Yellow Color Bins^a

Bin ID	Dominant Wavelength (nm)	
	Min.	Max.
A	582.0	584.5
B	584.5	587.0
C	587.0	589.5
D	589.5	592.0
E	592.0	594.5
F	594.5	597.0

a. Tolerance: ± 1 nm

Table 8: Orange Color Bins^a

Bin ID	Dominant Wavelength (nm)	
	Min.	Max.
A	597.0	600.0
B	600.0	603.0
C	603.0	606.0
D	606.0	609.0
E	609.0	612.0
F	612.0	615.0

a. Tolerance: ± 1 nm

Table 10: Red Color Bins^a

Bin ID	Dominant Wavelength (nm)	
	Min.	Max.
—	620.0	635.0

a. Tolerance: ± 1 nm

Table 11: Light Intensity (Iv) Bin Limits^a

Bin ID	Intensity (mcd)		Bin ID	Intensity (mcd)	
	Min.	Max.		Min.	Max.
A	0.11	0.18	N	28.50	45.00
B	0.18	0.29	P	45.00	71.50
C	0.29	0.45	Q	71.50	112.50
D	0.45	0.72	R	112.50	180.00
E	0.72	1.10	S	180.00	285.00
F	1.10	1.80	T	285.00	450.00
G	1.80	2.80	U	450.00	715.00
H	2.80	4.50	V	715.00	1125.00
J	4.50	7.20	W	1125.00	1800.00
K	7.20	11.20	X	1800.00	2850.00
L	11.20	18.00	Y	2850.00	4500.00
M	18.00	28.50	—	—	—

a. Tolerance: ±15%

Notes:

1. Bin categories are established for classification of products. Products may not be available in all categories. Please contact your Broadcom representative for information on currently available bins.
2. The Iv binning specification setup is for the lowest allowable Iv binning only. There is no upper Iv bin limits.

Figure 1: Relative Intensity vs. Wavelength

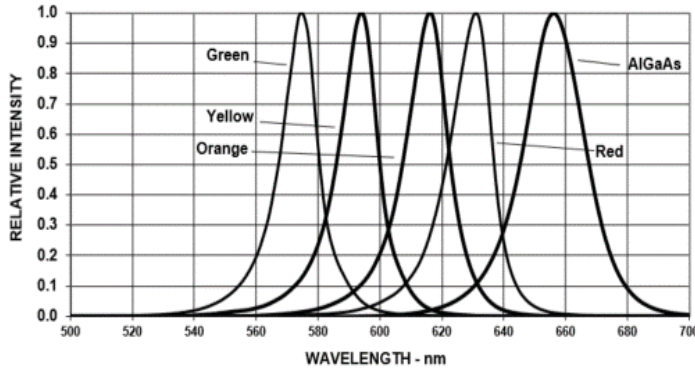

Figure 2: Forward Current vs. Forward Voltage

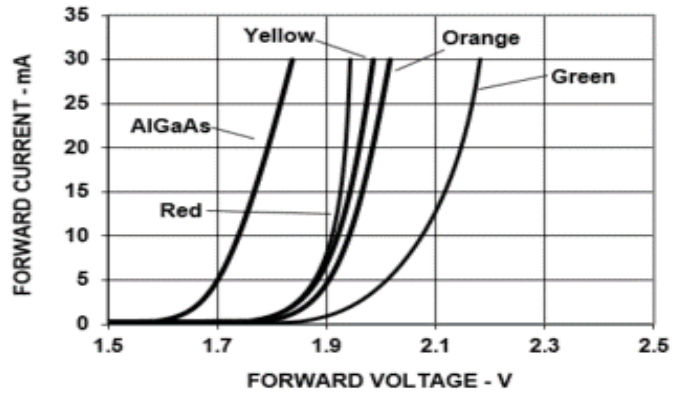

Figure 3: Luminous Intensity vs. Forward Current

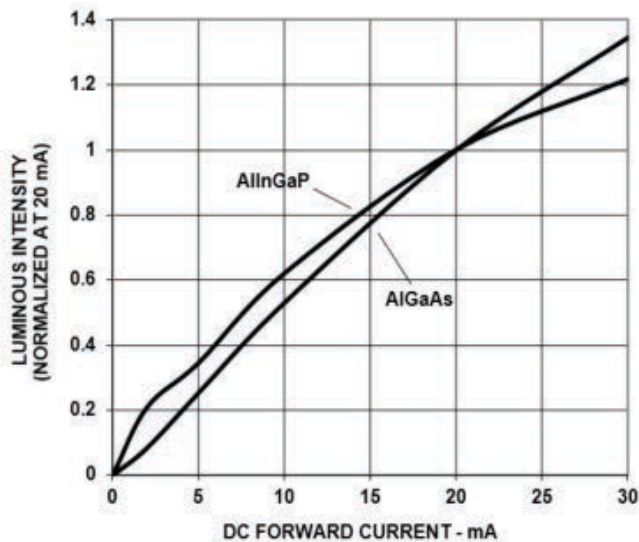

Figure 4: Maximum Forward Current vs. Ambient Temperature

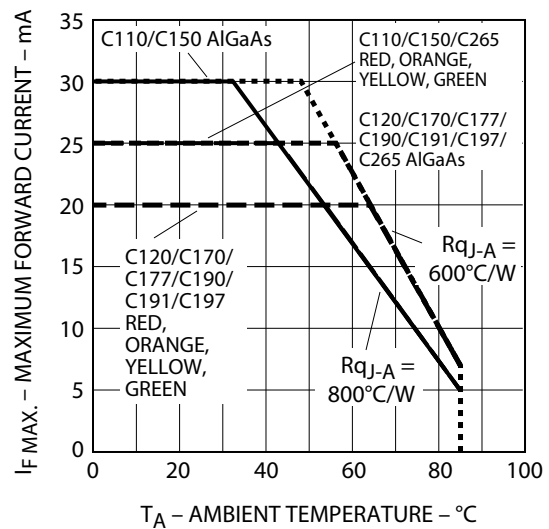

Figure 5: Relative Intensity vs. Angle for HSMx-C110

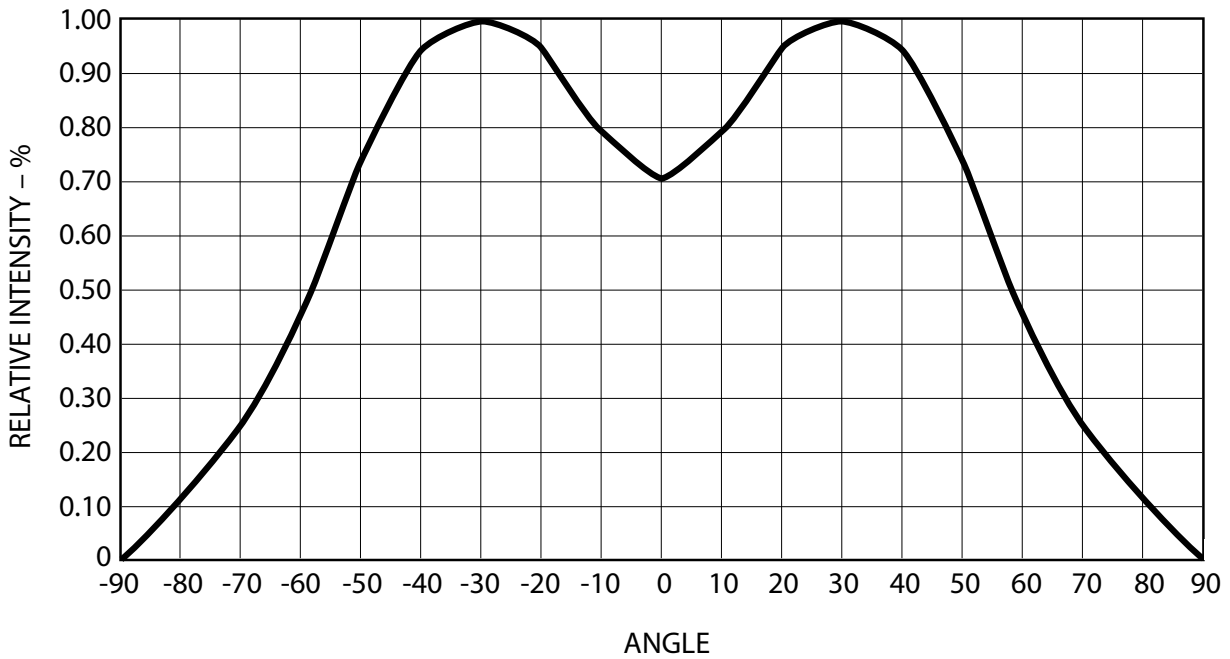
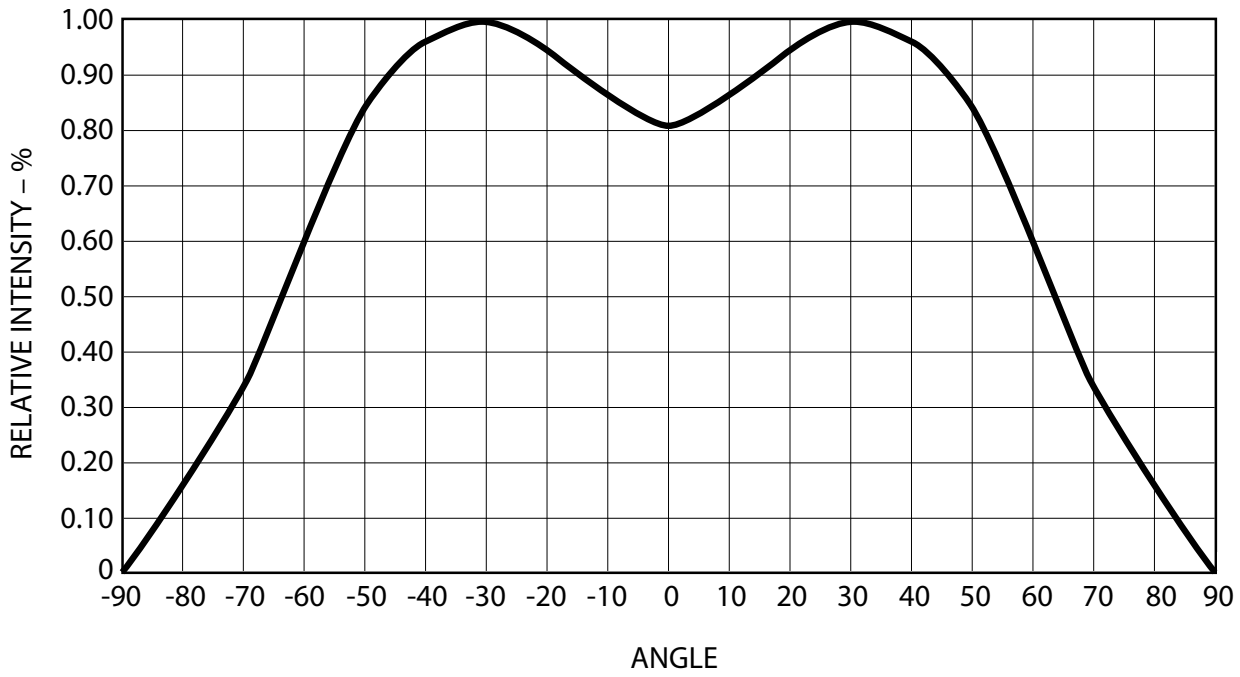

Figure 6: Relative Intensity vs. Angle for HSMx-C120

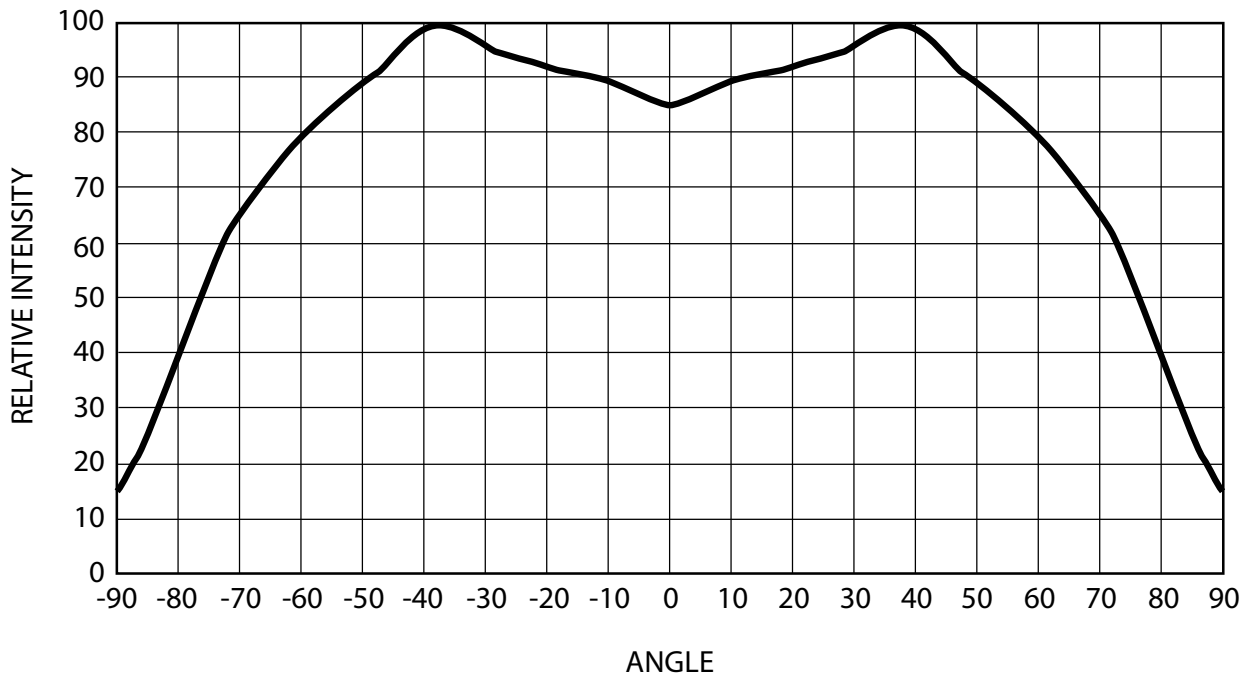
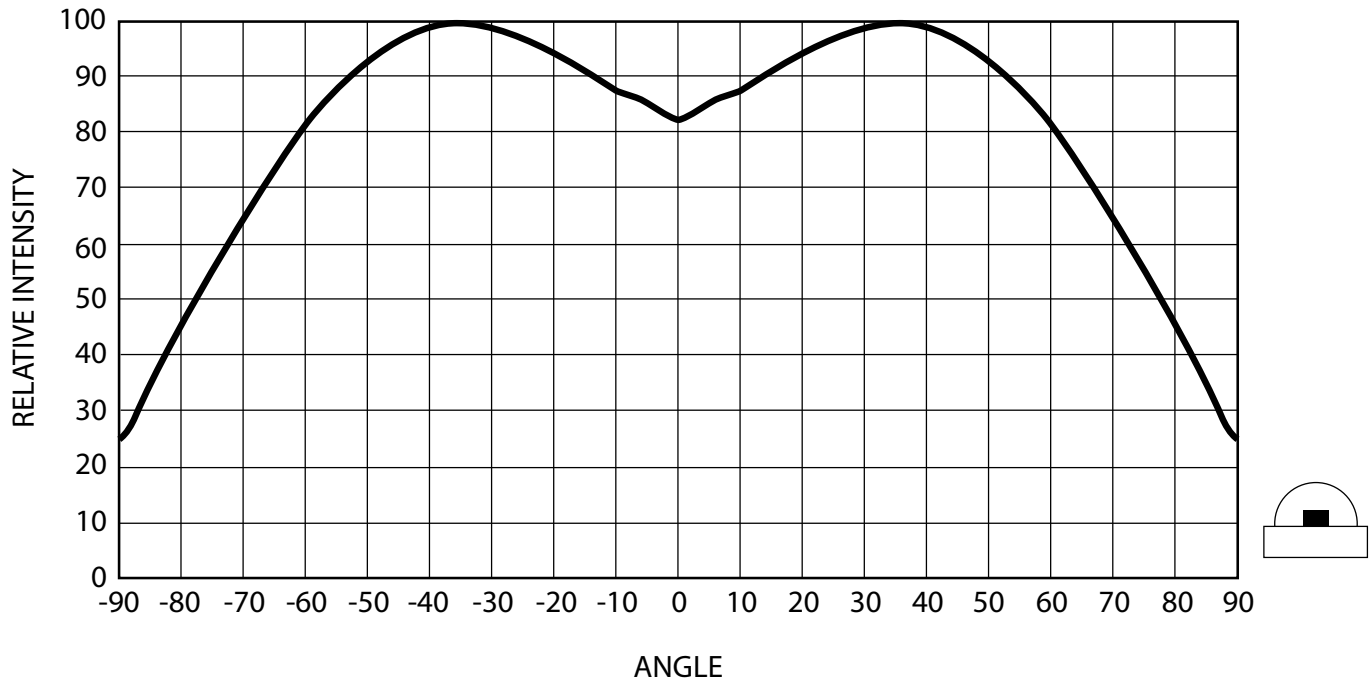

Figure 7: Relative Intensity vs. Angle for HSMx-C177 and C197

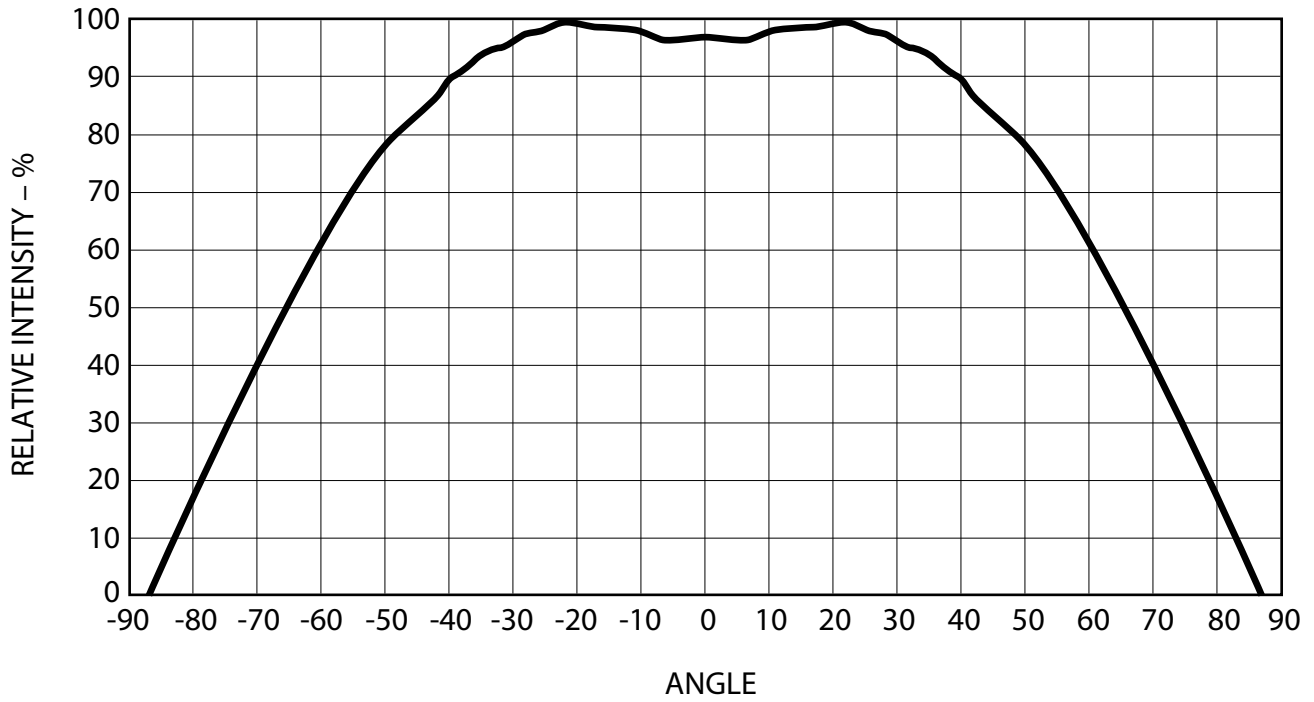

Figure 8: Relative Intensity vs. Angle for HSMx-C150, C170, C190, C191, and C265

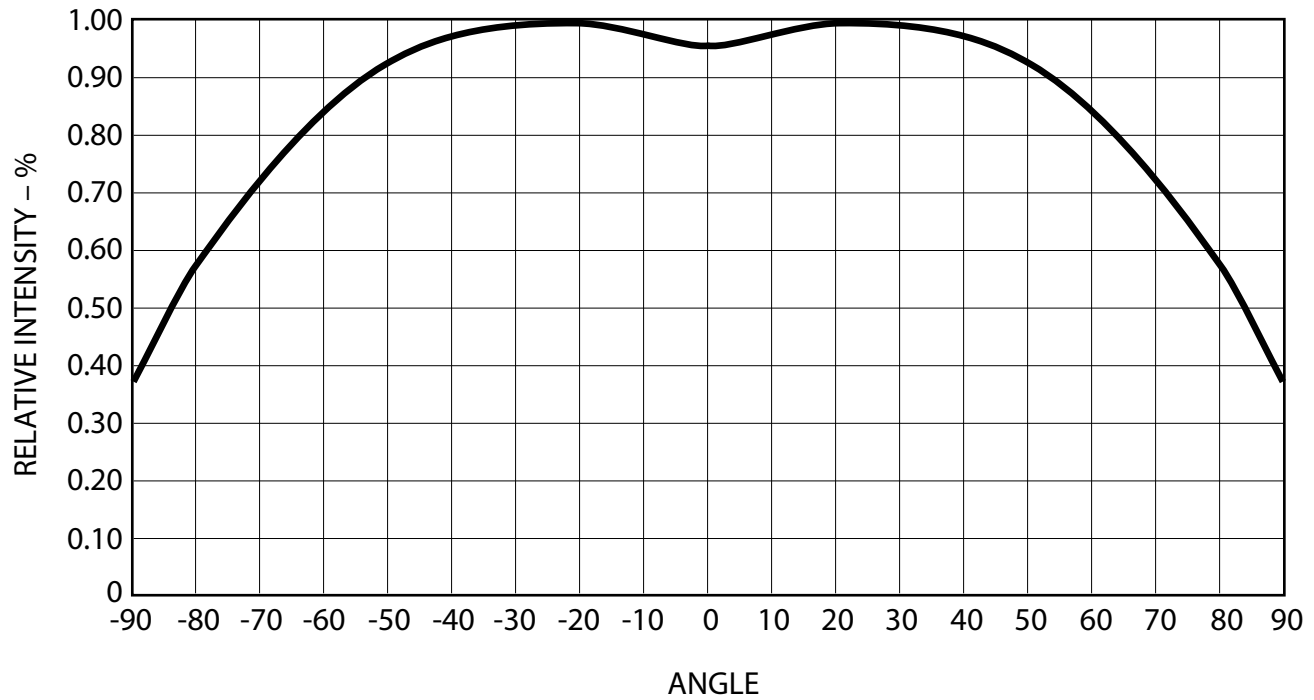

Figure 9: Recommended Reflow Soldering Profile

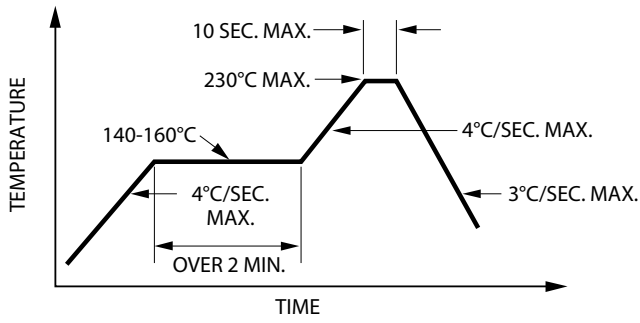

Figure 12: Recommended Soldering Pattern for HSMx-C170 and C177

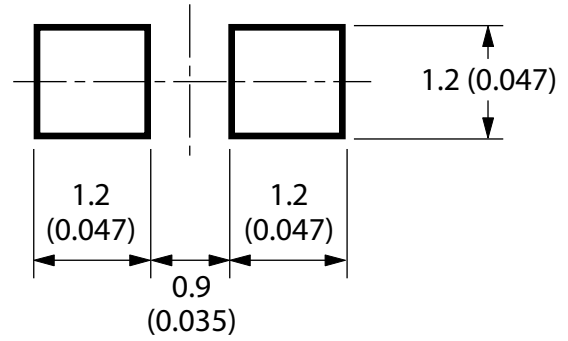

Figure 10: Recommended Pb-Free Reflow Soldering Profile

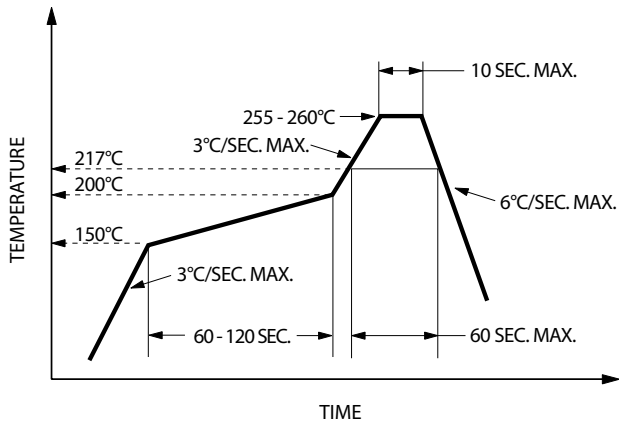

Figure 13: Recommended Soldering Pattern for HSMx-C190, C191, and C197

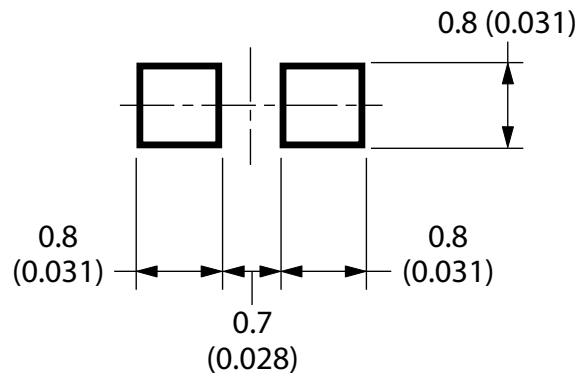

Figure 11: Recommended Soldering Pattern for HSMx-C150

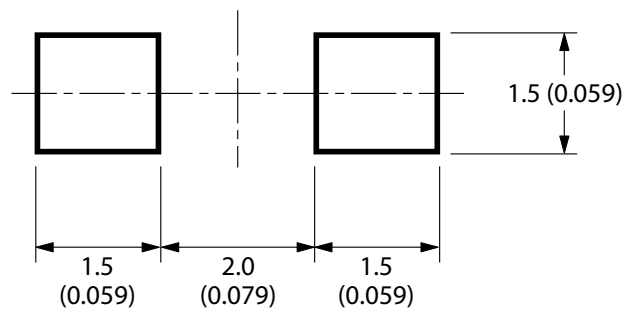

Figure 14: Recommended Soldering Pattern for HSMx-C110

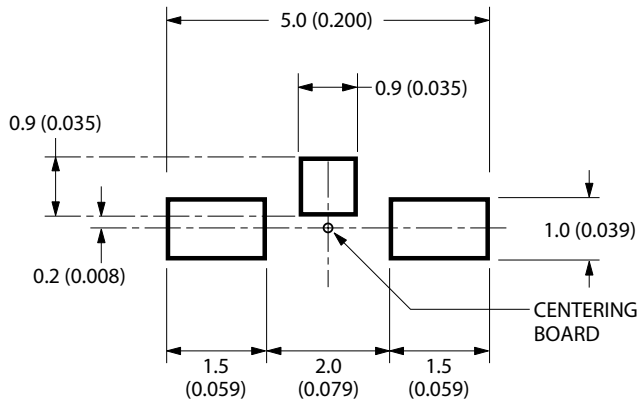

Figure 16: Recommended Soldering Pattern for HSMx-C265

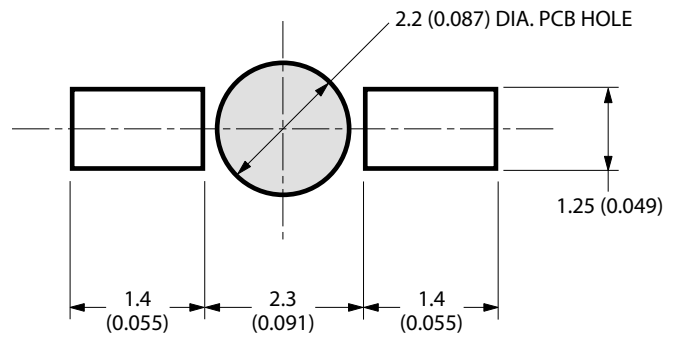

Figure 15: Recommended Soldering Pattern for HSMx-C120

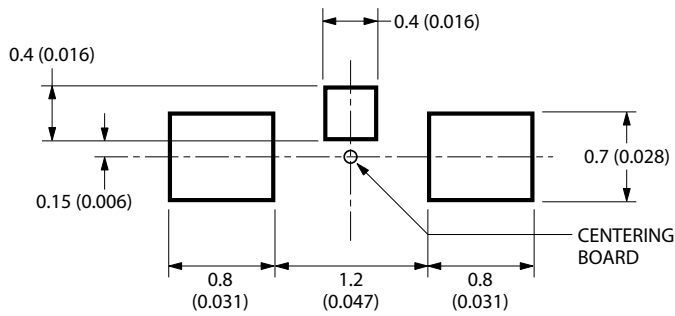

Figure 17: Reeling Orientation

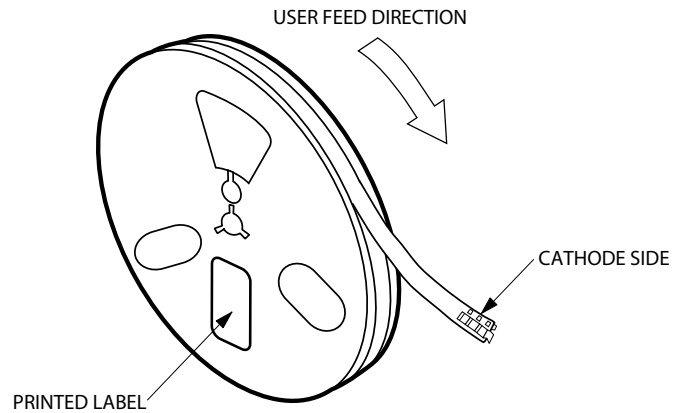
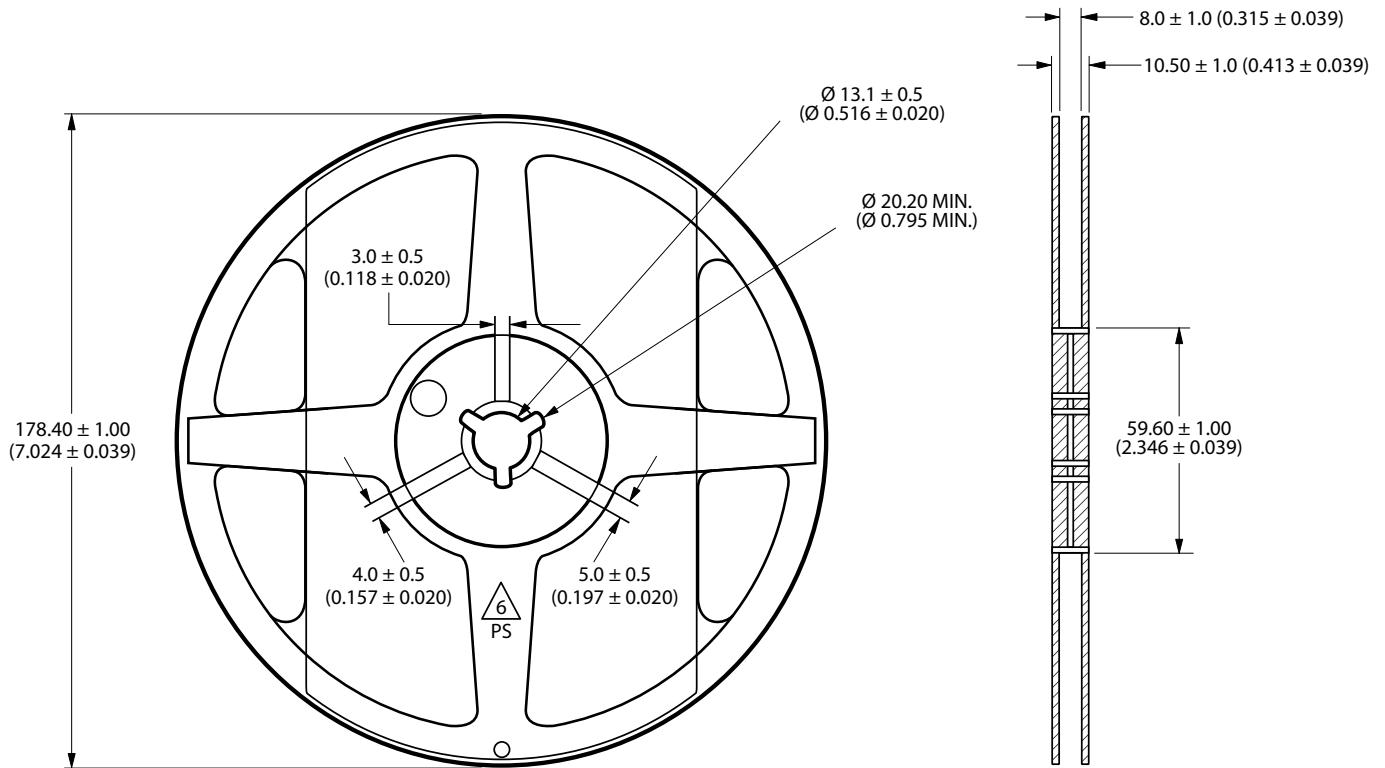

Figure 18: Reel Dimensions



NOTE: All dimensions are in millimeters (inches).

Figure 19: Tape Dimensions

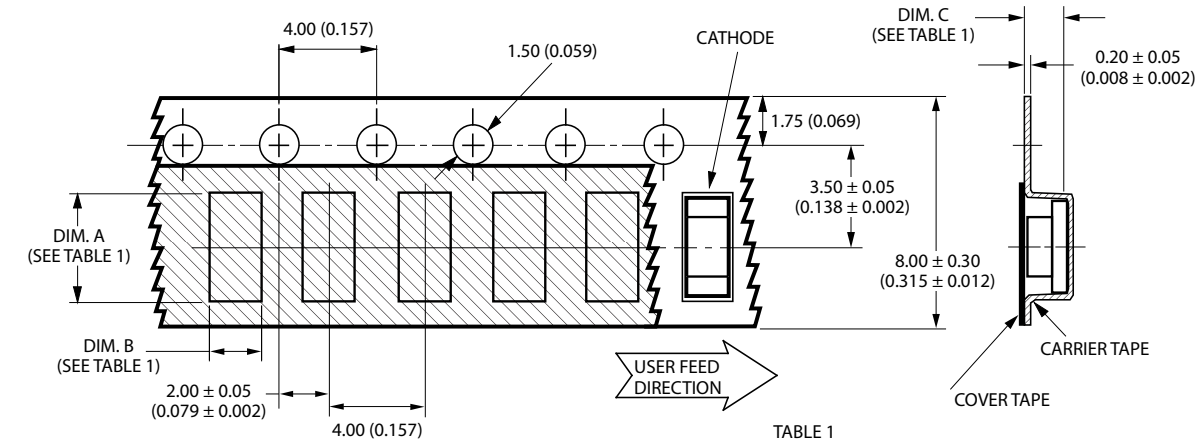

TABLE 1
DIMENSIONS IN MILLIMETERS (INCHES)

PART NUMBER	DIM. A ± 0.10 (0.004)	DIM. B ± 0.10 (0.004)	DIM. C ± 0.10 (0.004)
HSMx-C110 SERIES	3.40 (0.134)	1.70 (0.067)	1.20 (0.047)
HSMx-C120 SERIES	1.90 (0.075)	1.15 (0.045)	0.75 (0.030)
HSMx-C150 SERIES	3.50 (0.138)	1.88 (0.074)	1.27 (0.050)
HSMx-C170 SERIES	2.30 (0.091)	1.45 (0.057)	0.95 (0.037)
HSMx-C177 SERIES	2.30 (0.091)	1.40 (0.055)	0.60 (0.024)
HSMx-C190 SERIES	1.75 (0.069)	0.90 (0.035)	0.90 (0.035)
HSMx-C191 SERIES	1.86 (0.073)	0.89 (0.035)	0.87 (0.034)
HSMx-C197 SERIES	1.75 (0.069)	0.95 (0.037)	0.60 (0.024)

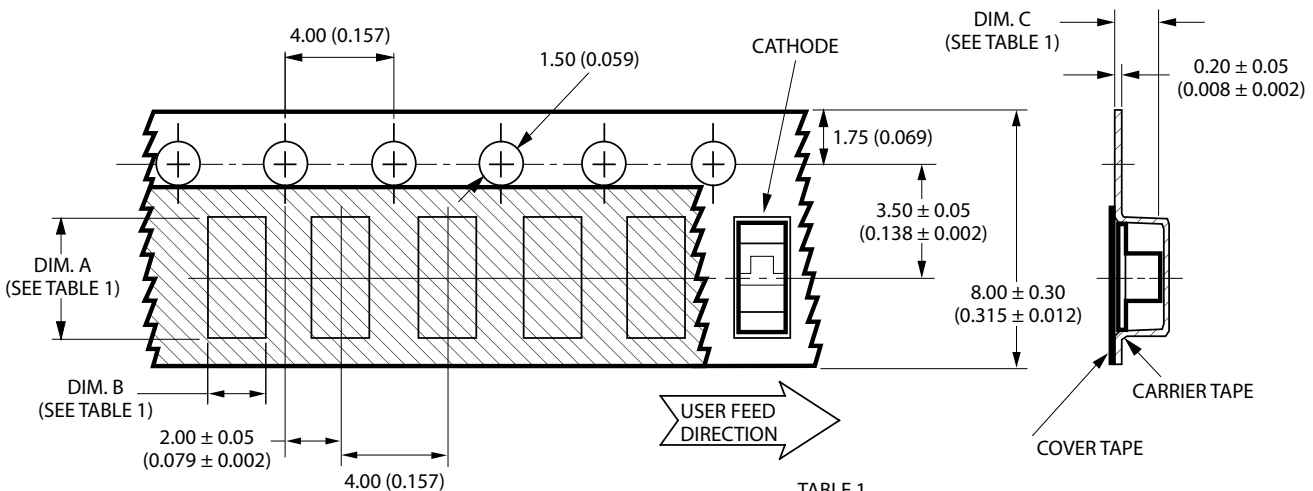
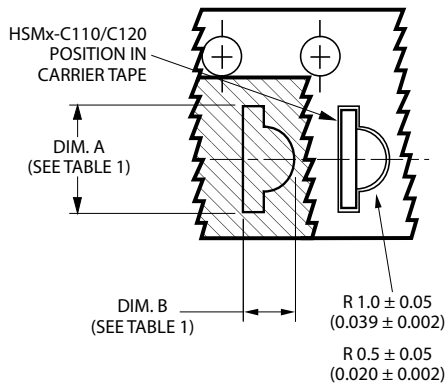
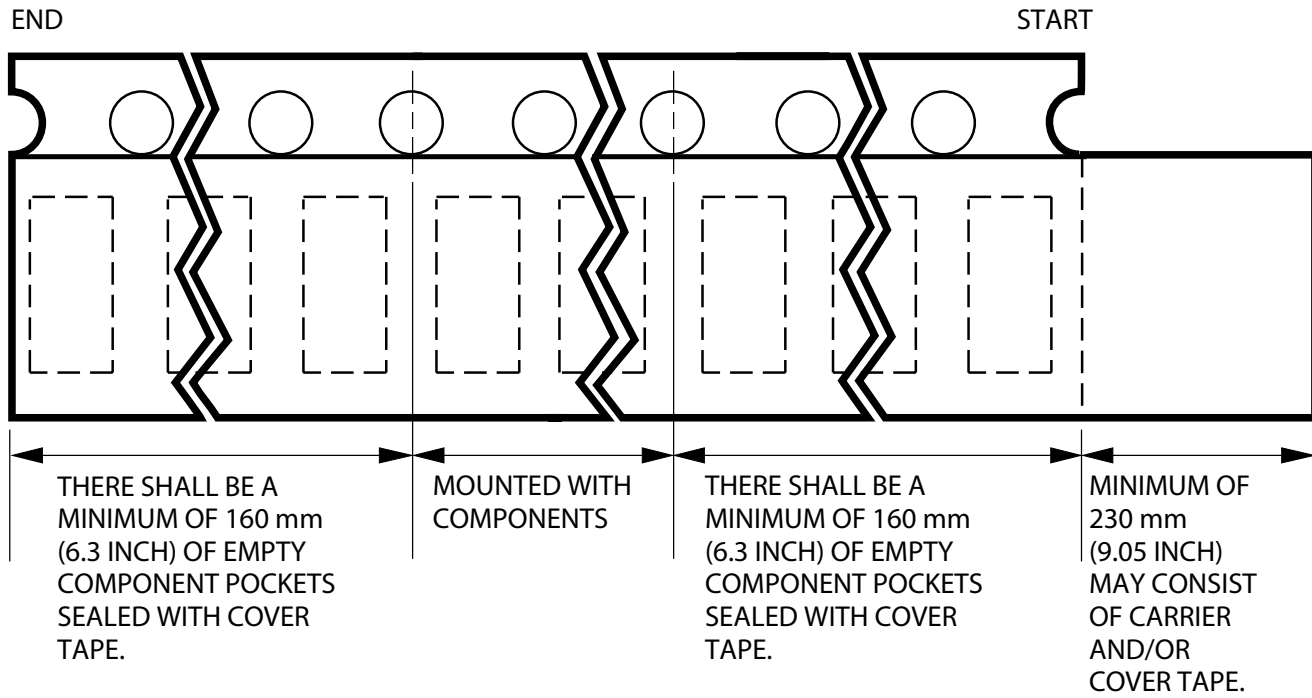

TABLE 1
DIMENSIONS IN MILLIMETERS (INCHES)

PART NUMBER	DIM. A ± 0.10 (0.004)	DIM. B ± 0.10 (0.004)	DIM. C ± 0.10 (0.004)
HSMx-C265 SERIES	3.70 (0.146)	1.45 (0.057)	1.30 (0.051)

Figure 20: Tape Leader and Trailer Dimensions



Notes:

1. All dimensions are in millimeters (inches).
2. Tolerance is ± 0.1 mm (± 0.004 in.) unless otherwise specified.

Precautionary Notes

Soldering

- Do not perform reflow soldering more than twice. Observe necessary precautions for handling a moisture-sensitive device as stated in the following section.
- Do not apply any pressure or force on the LED during reflow and after reflow when the LED is still hot.
- Use reflow soldering to solder the LED. Use hand soldering only for rework if unavoidable, but it must be strictly controlled to the following conditions:
 - Soldering iron tip temperature = 310°C max.
 - Soldering duration = 2 seconds max.
 - Number of cycles = 1 only
 - Power of soldering iron = 50W max.
- Do not touch the LED package body with the soldering iron except for the soldering terminals, as it may cause damage to the LED.
- Confirm beforehand whether the functionality and performance of the LED is affected by hand soldering.

Figure 21: Recommended Lead-Free Reflow Soldering Profile

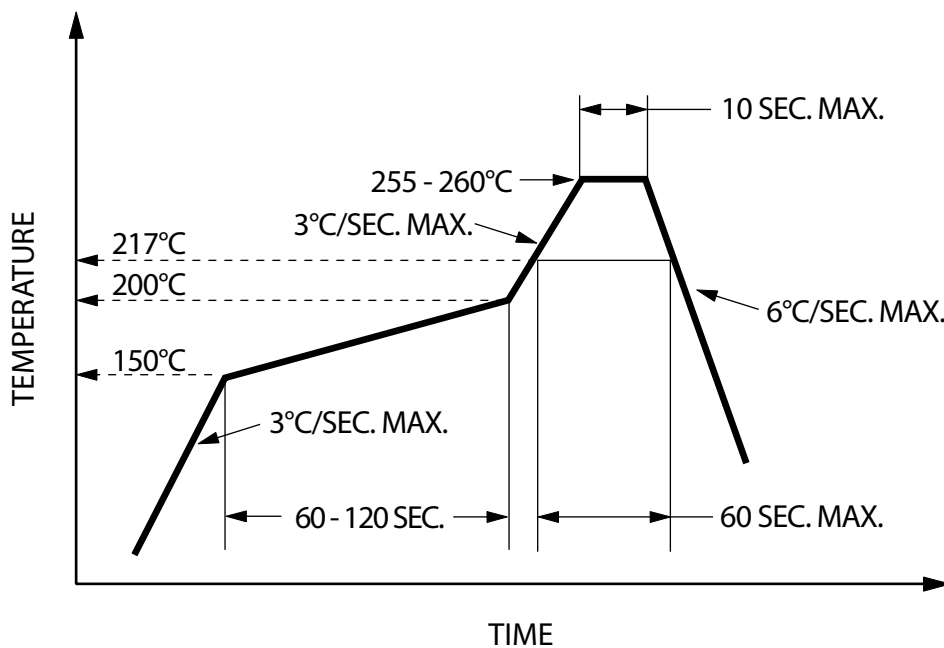

Handling Precautions

This product has a Moisture Sensitive Level 2a rating per JEDEC J-STD-020. Refer to Broadcom Application Note AN5305, *Handling of Moisture Sensitive Surface Mount Devices*, for additional details and a review of proper handling procedures.

- Before use:
 - An unopened moisture barrier bag (MBB) can be stored at 40°C/90% RH for 12 months. If the actual shelf life has exceeded 12 months and the Humidity Indicator Card (HIC) indicates that baking is not required, then it is safe to reflow the LEDs per the original MSL rating.
 - Do not open the MBB prior to assembly (for example, for IQC). If unavoidable, the MBB must be properly resealed with fresh desiccant and the HIC. The exposed duration must be taken in as floor life.
- Control after opening the MBB:
 - Read the HIC immediately upon opening of MBB.
 - Keep the LEDs at 30°/60%RH at all times, and complete all high-temperature-related processes, including soldering, curing, or rework, within 672 hours.
- Control for unfinished reel:

Store unused LEDs in a sealed MBB with desiccant or a desiccator at 5%RH.
- Control of assembled boards:

If the PCB soldered with the LEDs is to be subjected to other high-temperature processes, store the PCB in a sealed MBB with desiccant or a desiccator at 5% RH to ensure that all LEDs have not exceeded their floor life of 672 hours.
- Baking is required if:
 - The HIC indicator indicates a change in color for 10% and 5%, as stated on the HIC.
 - The LEDs are exposed to conditions of 30°C/60% RH at any time.
 - The LED's floor life has exceeded 672 hours.

The recommended baking condition is $60\pm 5^{\circ}\text{C}$ for 20 hours.

Baking can be done only once.

Application Precautions

- The drive current of the LED must not exceed the maximum allowable limit across temperature as stated in the data sheet. Constant current driving is recommended to ensure consistent performance.
- Circuit design must cater to the whole range of forward voltage (V_F) of the LEDs to ensure that the intended drive current can always be achieved.
- The LED exhibits slightly different characteristics at different drive currents, which may result in a larger variation of performance (meaning: intensity, wavelength, and forward voltage). Set the application current as close as possible to the test current to minimize these variations.
- Driving the LED at low current (2 mA) will not cause functional failures to the LED (for example, open/short). However, the variation in intensity will be larger than the existing intensity bin ratio of 1:1.6.
- If the LED is intended to be used along with an LED of another color to achieve color mixing, Broadcom does not guarantee the consistency of the resultant color. Do contact your Broadcom sale representative for such application.
- The LED is not intended for reverse bias. Use other appropriate components for such purposes. When driving the LED in matrix form, ensure that the reverse bias voltage does not exceed the allowable limit of the LED.
- Avoid a rapid change in ambient temperature, especially in high-humidity environments, because it causes condensation on the LED.
- If the LED is intended to be used in a harsh or outdoor environment, protect the LED against damages caused by rain water, water, dust, oil, corrosive gases, external mechanical stresses, and so on.

Eye Safety Precautions

LEDs may pose optical hazards when in operation. Do not look directly at operating LEDs because it might be harmful to the eyes. For safety reasons, use appropriate shielding or personal protective equipment.

Disclaimer

Broadcom's products and software are not specifically designed, manufactured, or authorized for sale as parts, components, or assemblies for the planning, construction, maintenance, or direct operation of a nuclear facility or for use in medical devices or applications. The customer is solely responsible, and waives all rights to make claims against Broadcom or its suppliers, for all loss, damage, expense, or liability in connection with such use.

Copyright © 2005–2022 Broadcom. All Rights Reserved. The term “Broadcom” refers to Broadcom Inc. and/or its subsidiaries. For more information, go to www.broadcom.com. All trademarks, trade names, service marks, and logos referenced herein belong to their respective companies.

Broadcom reserves the right to make changes without further notice to any products or data herein to improve reliability, function, or design. Information furnished by Broadcom is believed to be accurate and reliable. However, Broadcom does not assume any liability arising out of the application or use of this information, nor the application or use of any product or circuit described herein, neither does it convey any license under its patent rights nor the rights of others.



Lead (Pb) Free
RoHS Compliant