

# AA-3000 ZOOM

RigExpert®

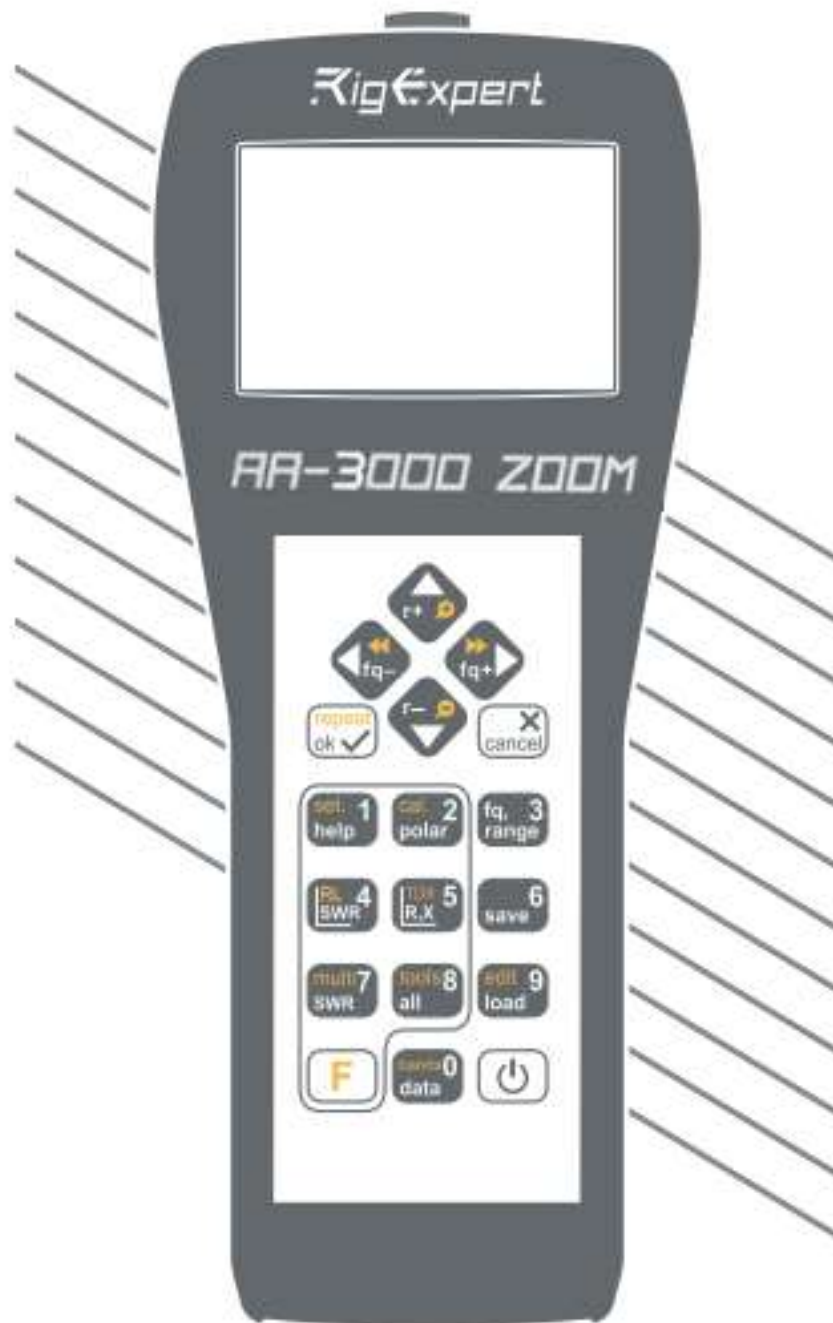

User's manual

For latest manuals and software updates,  
please visit

<http://rigexpert.com>

# Table of contents

<b>Introduction</b>	<b>5</b>
<b>Operating the AA -3000 ZOOM</b>	<b>6</b>
First time use	6
Main menu	6
Multifunctional keys	7
Connecting to your antenna	7
SWR chart	8
Chart ZOOM	8
Data screen	9
Frequency and range entry	9
Return loss chart	9
R X chart	10
Smith chart	10
Memory operation	11
SWR meter SWR2Air	11
Display all parameters	12
MultiSWR mode	13
Multiband mode	13
HOLD functions	14
Frequency generator	14
My Bands	15
<b>Applications</b>	<b>16</b>
Antennas	16
Coaxial lines	17
Measurement of other elements	24
<b>Annexes</b>	<b>27</b>
Annex 1: Specifications	27
Annex 2: Precautions	28
Annex 3: Tools menu	29

Annex 4: Setup menu .....	<b>34</b>
Annex 5: TDR mode .....	<b>35</b>
Annex 6: Calibration .....	<b>39</b>
Annex 7: Dummy loads .....	<b>41</b>
<b>DECLARATION OF CONFORMITY</b> .....	<b>42</b>

# Introduction

Thank you for purchasing a **RigExpert AA-3000 ZOOM** Antenna and Cable Analyzer! We did our best to make it powerful yet easy to use.

The analyzer is designed for measuring SWR (standing wave ratio), return loss, cable loss, as well as other parameters of cable and antenna systems in the range of 100 kHz to 3000 MHz. A built-in ZOOM capability makes graphical measurements especially An integrated Time Domain Reflectometer mode can be used to locate a fault within the feedline system. The analyzer is equipped with a Bluetooth Low Energy module for a wireless connection with your laptop, tablet or smartphone.

**The following tasks are easily accomplished by using this analyzer:**

- Rapid check-out of an antenna
- Tuning an antenna to resonance
- Comparing characteristics of an antenna before and after specific event (rain, hurricane, etc.)
- Making coaxial stubs or measuring their parameters
- Cable testing and fault location, measuring cable loss and characteristic impedance
- Measuring capacitance or inductance of reactive loads



1. Antenna connector
2. Color display
3. Keypad
4. USB connector

# Operating the AA-3000 ZOOM

## First time use

Please insert three AA sized batteries (alkaline, Ni-MH or LiPO accumulators) into the battery compartment of the analyzer, watching the polarity.



Press the  (Power) key located at the bottom-right corner of the keypad to turn on the analyzer. After displaying the initial message (showing a firmware version and a serial number of the instrument), a **Main menu** appears on the screen.

*The analyzer will be turned off automatically if not in use for too long.*

## Main menu

The Main menu acts as a starting point from where different tasks may be launched.



Use  (Cursor up) and  (Cursor down) keys to scroll through the menu, then press  (OK) to select an item. For your convenience, a battery indicator is shown at the top-left corner of the screen. This indicator is replaced with a USB icon when the analyzer is connected to your computer.

*You may use hot keys for the quick access to certain tasks. For instance, press the  (SWR chart) button to open the SWR chart screen immediately.*

# Multifunctional keys

Most keys on the analyzer's keypad perform several functions.

For instance, numbers (1) are used to enter frequency and other numerical parameters. Main functions (2) provide quick access to most common tasks. Alternative functions (3) are executed if the user holds the **F** (Functional) key. For the convenience, alternative functions are marked with yellow.

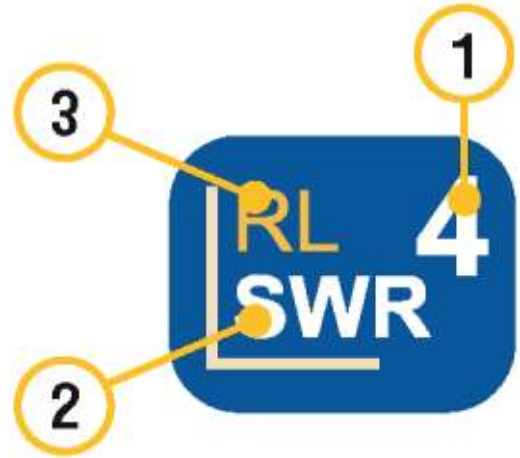

You may press the **1** (Help) key to open a help screen listing all active hot keys.

# Connecting to your antenna

Plug the cable to your analyzer's antenna connector, and then tighten the rotating sleeve. The rest of the connector, as well as the cable, should remain stationary.

*If you twist other parts of the connector when tightening or loosening, damage may easily occur. Twisting is not allowed by design of the N-connector.*

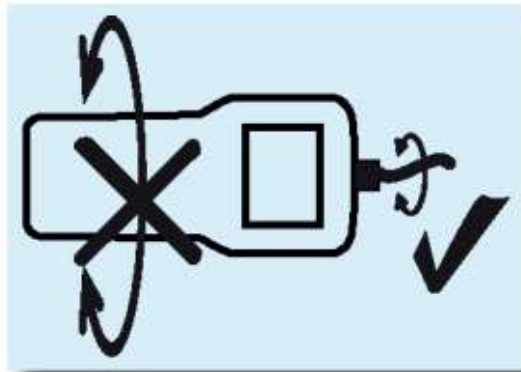

## SWR chart

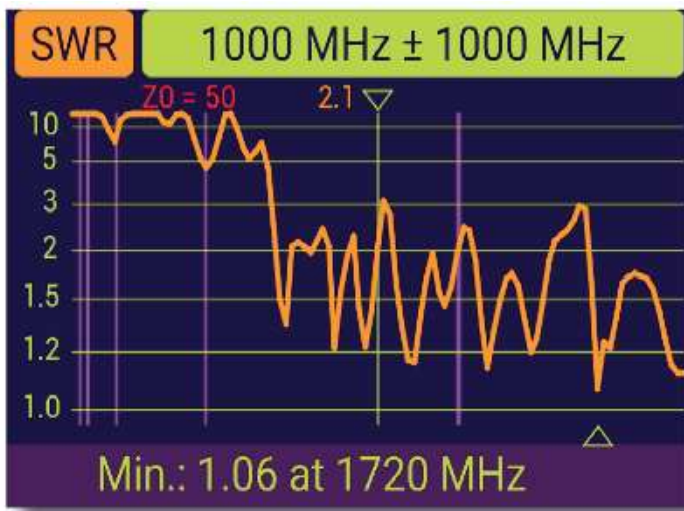

Once your antenna is connected to the analyzer, it is time to measure its characteristics. Press the **4** (SWR chart) key to open the SWR chart screen, then press **✓** (OK) to start a new measurement.

A few moments later, the result will be displayed on the analyzer's screen.

Press the **F** + **✓** key combination to run a continuous sweep.

*A small triangle at the bottom of the chart corresponds to a point at which the SWR reaches its minimum.*

## Chart ZOOM

Use the arrow keys to increase or decrease the center frequency or the scanning range. Watch the chart zooming in or out, or changing its position. Use the **F** (Functional key) and **▲** (Cursor up) or **▼** (Cursor down) key combination to zoom the vertical scale

Do not forget to press the **✓** (OK) key for the new measurement to start.  
Press **F** (Functional key) and **0** to quickly choose a radio amateur band.



## Data screen

The data screen is available in all chart modes. Press the **0** (Data) key to display various parameters of a load at cursor.



## Frequency and range entry

To enter the center frequency or the sweep range, press the **0** (Frequency, Range) key.



Use cursor keys to navigate, or the **0** to **9** keys to enter values, press the  (OK) key to apply. Hold **F** key for band selection, use navigation keys for choosing bandplan, amateur regional bandplan and custom bandplans are available (if they were defined), use **▲** **▼** to apply band settings.

## Return loss chart

The return loss (**RL**) chart, which is very similar to the **SWR chart**, is activated by pressing the **F** (Functional key) and **4** (RL chart) key combination in the **Main menu**.

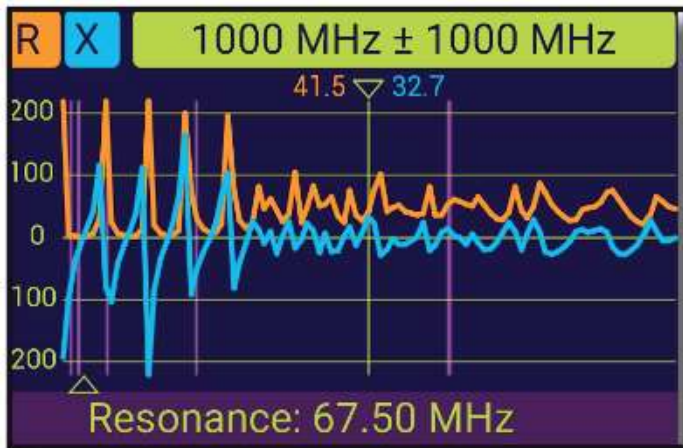

## R,X chart

Press the **5** (R,X chart) key in the **Main menu** to access the **R,X chart** mode.

Positive values of reactance (X) correspond to inductive load, while negative values correspond to capacitive load.

The chart will display **R** and **X** for series or parallel models of a load. Press **F** (Functional key) and **1** to switch between these models.

*The marker at the bottom of the screen shows a resonant frequency closest to the center of the scan.*

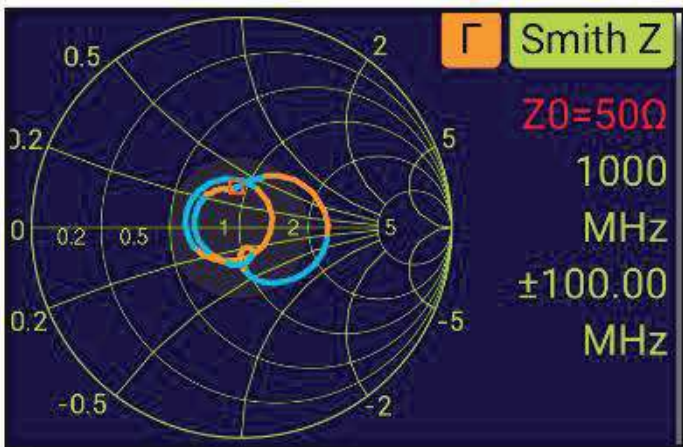

## Smith chart

The **2** (Smith chart) key opens a screen where the reflection coefficient is plotted on the **Smith chart**.

For a list of hot keys, press the **1** (Help) key, as usual.

*A small marker is used to indicate the center frequency.*

## Memory operation

Device has 250 unified slots for storing your records. Record operations are linked to relevant data screens – SWR, RX, RL, Smith charts mark their records with ‘Z’ slot identifier, TDR chart marks with ‘T’ identifier.

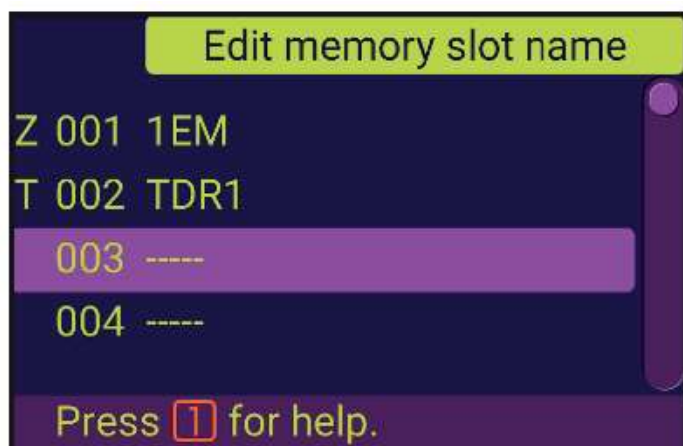

Use **6**, **9**, or **F** and **9** respectively for Load, Save or Edit Name operations in relevant data screens.

## SWR meter, SWR2Air.

This mode allows to measure SWR at one frequency. Mode provides analog meter or historical trend view and has SWR2Air possibility. Change frequency with **◀**, **▶**, **3** buttons. Press **✓** to start or stop the measurement, **F** + starts measurement with SWR2Air function.



SWR2Air allows to manifest measured values by speaker or radio(air), using the same measured antenna. Measuring is coded in Morse code, values in range 1.0–4.9 come as two digit word without dot, values 5.0 and above are represented as long dash. Portable, FM –able radio is typically used to pick up radio channel. Change transmit frequency by pressing **F** + **3**, other SWR2Air related parameters you can find in Setup menu. Use **F** and **▲** to switch between meter and trend view.

## Display all parameters

To display various parameters of a load on a single screen, press the **8** (All) key.

All	Z0=50Ω	1000 MHz	
SWR	9.8	RL	1.77dB
Z	236.2Ω	Phase	-21.0°
Series model			
R	117.5Ω	L	-32.6nH
X	-205.0Ω	C	0.8pF
☑ - start/stop, ⓘ - help.			

*Do not be confused by negative values of L or C. This can be useful for experienced users.*

### This screen displays values for series as well as *parallel* models of impedance of a load.

- In the series model, impedance is expressed as resistance and reactance connected in series:

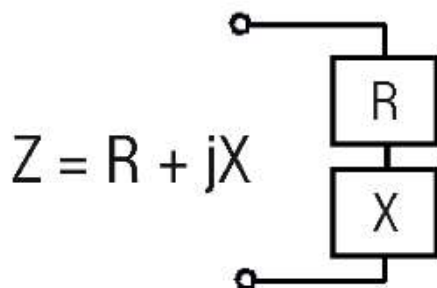

- In the parallel model, impedance is expressed as resistance and reactance connected in parallel:

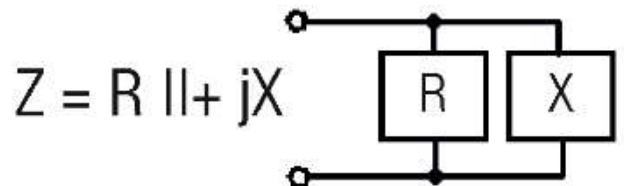

# MultiSWR mode

Press the **F** (Functional key) and **3** (Multi) key combination to see the SWR at up to five different frequencies. This mode may be useful for tuning multi-band antennas.



Use **▲** (Up) and **▼** (Down) cursor keys to select a frequency to be set or changed, then press the **3** (Frequency) key to enter a new value. Do not forget to press the **✓** (OK) key to start the measurement.

# Multiband mode

In Tools menu you can find another useful mode for tuning multiband antennas. Mode provides up to 3 overlapped charts of selected bands. In-band values are shown as curve, minimal SWR of band and frequency at this point provided by text. Measuring is done in continuous “in loop” manner, providing conveniently “alive” picture.

Use **▲** **▼** buttons to choose group, press **3** and select the band for curve. Use the **✓** button to start and stop measuring.





# HOLD functions

RL and Smith charts. You can keep some measuring result on screen next to fresh measuring result. There are two ways of using HOLD.

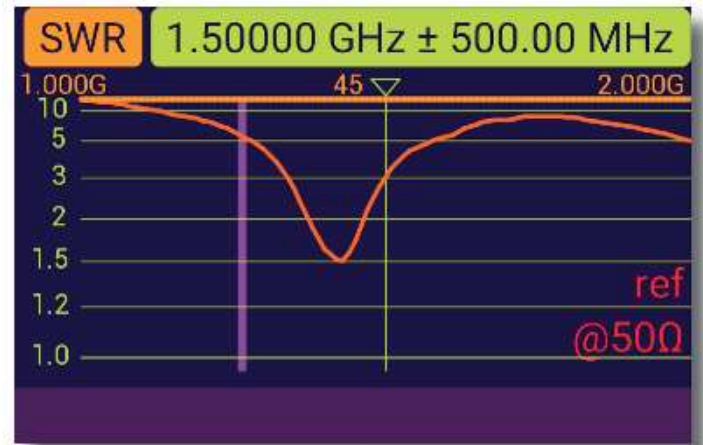

Using **F** + **1** keys allows you to make current curve as reference curve (you can use even RECORD curve). Reference curve will be retained until next arbitrary user action. Using **F** + **6** enables HOLD last operation. New measurement will be shown with previous curve. Text mark “ref” or “last” indicates current mode of HOLD functionality.

# Frequency generator

You can provide on RF connector of analyzer square-shaped (or close to it, depends on exact frequency) unmodulated signal. It will be persistent and stable, unlike in any measuring mode. All device’s range is accesible with resolution of 1 Hz. Use  button for enabling and dissabling signal at output. “Square wave” icon indicates active output.

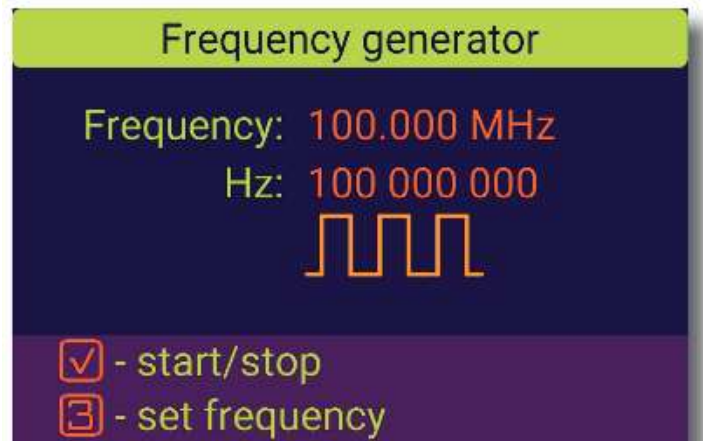

# My Bands

For advanced usage of analyzer it is sometimes beneficial to have custom, more flexible bands instead of rigid amateur regional bands. This functionality gives you possibility to manage 10 custom bandplans, which one can contain up to 100 user defined bands. By default, bandplans are named as Plan A–J, with bands named A00–A99 (for Plan A), every band has range as 0, making band in such way unconfigured/–dissabled. Bandplans that have 0 configured bands considered unconfigured. Unconfigured bandplans and bands are removed from access list (Frequency entry, Multiband).

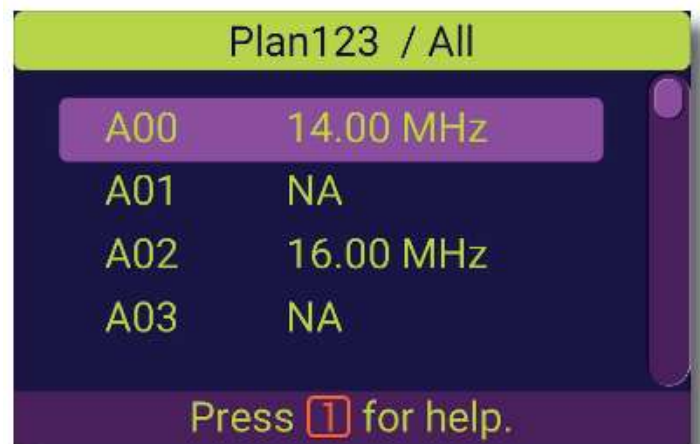
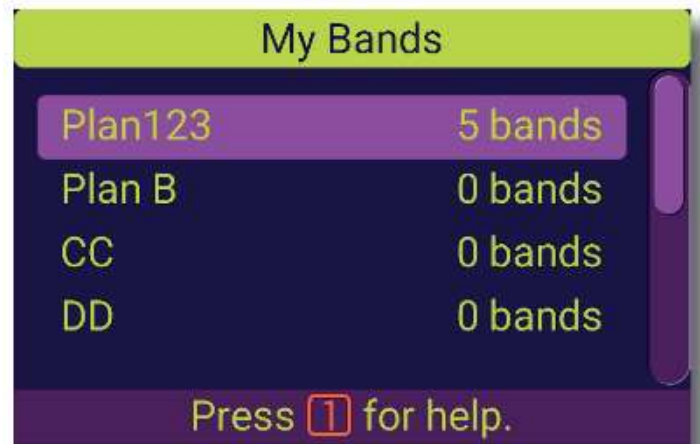

Configured bands will appear in access list accordingly to their default number (exactly as they ordered there), regardless of their given name or central frequency. Considering that, we can recommend to place most frequently used bands at start of list, you can also leave “gaps”, having in mind, to insert later some bands with expected place.

Please, explore built–in help for other details and keys functionality.

# Applications

## Antennas

### Checking the antenna

It is a good idea to check an antenna before connecting it to the receiving or transmitting equipment. The SWR chart mode is good for this purpose. Also you can use Multŷ tool located in Tools. Multŷ will check your rig against all HAM bands defined in your region and rate all bands where SWR lower than 3.0 in range of 1...5 stars. Select band for detailed evaluation and press  to run SWR chart for this band.

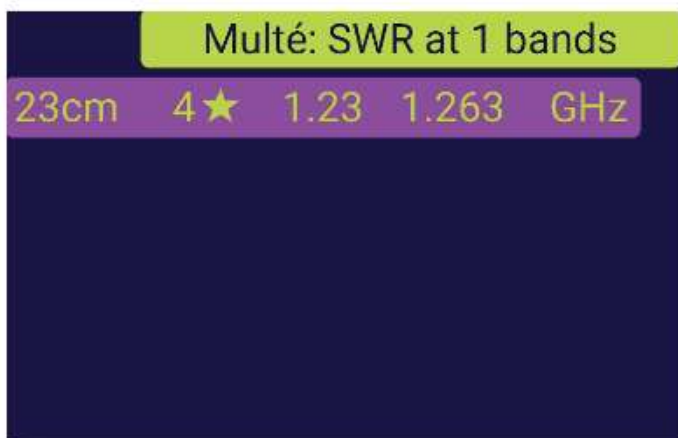

Multŷ: SWR at 1 bands

23cm	4★	1.23	1.263	GHz
------	----	------	-------	-----

The picture on the left shows the result for one band real antenna.

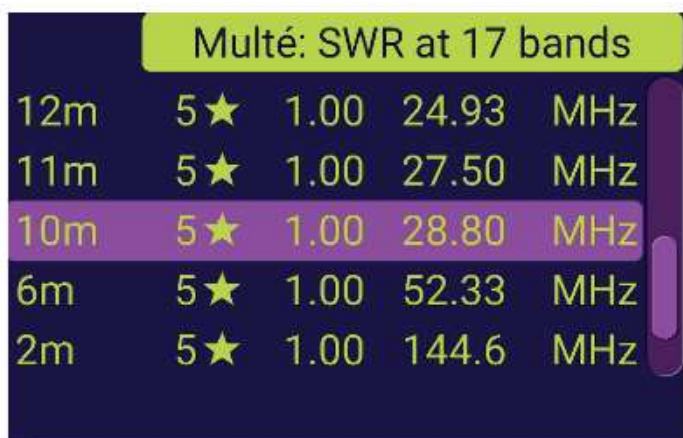

Multŷ: SWR at 17 bands

12m	5★	1.00	24.93	MHz
11m	5★	1.00	27.50	MHz
10m	5★	1.00	28.80	MHz
6m	5★	1.00	52.33	MHz
2m	5★	1.00	144.6	MHz

The next screen shot shows result for 50 Ohm calibrated load, making in such way ideal all-band antenna (in mathematical terms only).



## Adjusting the antenna

When the measurement diagnoses that the antenna is off the desired frequency, the analyzer can help in adjusting it. Physical dimensions of a simple antenna (such as a dipole) can be adjusted knowing the actual resonant frequency and the desired one. Other types of antennas may contain more than one element to adjust (including coils, filters, etc.), so this method will not work. Instead, you may use the SWR mode, the All parameters mode or the Smith chart mode to continuously see the results while adjusting various parameters of the antenna.

For multi-band antennas, use the MultiSWR mode. You can easily see how changing one of the adjustment elements (trimming capacitor, coil, or physical length of an aerial) affects SWR at up to five different frequencies.

## Coaxial lines

### Open- and short-circuited cables

The pictures on the right show R and X charts for a piece of cable with open- and short-circuited far end. A resonant frequency is a point at which X (reactance) equals to zero:

- In the open-circuited case, resonant frequencies correspond to (left to right)  $1/4$ ,  $3/4$ ,  $5/4$ , etc. of the wavelength in this cable;
- For the short-circuited cable, these points are located at  $1/2$ ,  $1$ ,  $3/2$ , etc. of the wavelength.

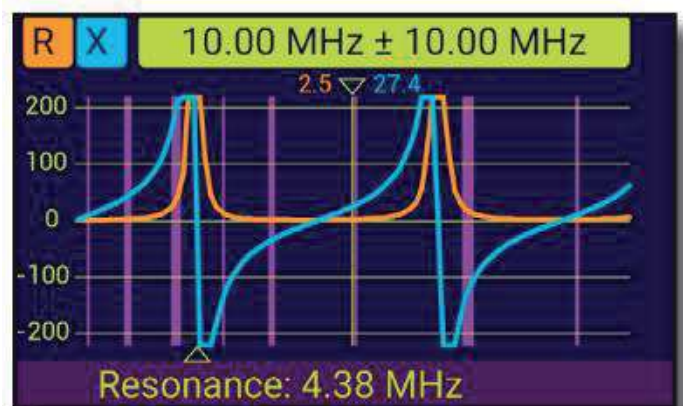

## Cable length measurement

Resonant frequencies of a cable depend on its length as well as on the velocity factor. A velocity factor is a parameter which characterizes the slowdown of the speed of the wave in the cable compared to vacuum. The speed of wave (or light) in vacuum is known as the electromagnetic constant:  $c=299,792,458$  meters (or **983,571,056 feet**) per second.

Each type of cable has different velocity factor: for instance, for RG-58 it is 0.66. Notice that this parameter may vary depending on the manufacturing process and materials the cable is made of.

To measure the physical length of a cable,

1. Locate a resonant frequency by using the **R,X chart**.

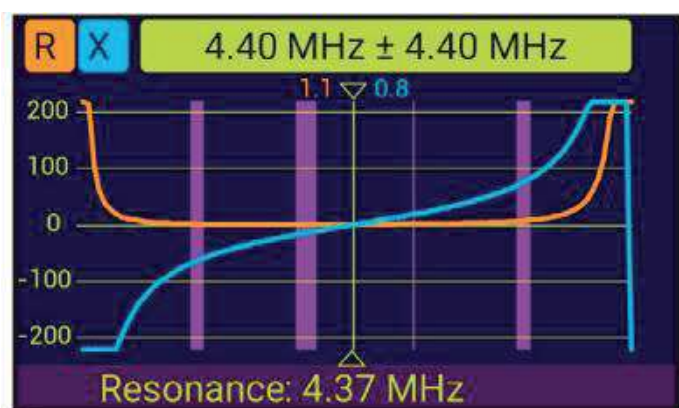

*Example:*

*The 1/4-wave resonant frequency of a piece of open-circuited RG-58 cable is 4370 kHz.*

2. Knowing the electromagnetic constant and the velocity factor of the particular type of cable, find the speed of electromagnetic wave in this cable.

$$\begin{aligned} 299,792,458 * 0.66 &= \\ 197,863,022 \text{ meters per second} \\ &\text{ - or -} \\ 983,571,056 * 0.66 &= \\ 649,156,897 \text{ feet per second} \end{aligned}$$

3. Calculate the physical length of the cable by dividing the above speed by the resonant frequency (in Hz) and multiplying the result by the number which corresponds to the location of this resonant frequency (1/4, 1/2, 3/4, 1, 5/4, etc.)

$$197,863,022 / 4,370,000 \times (1/4) =$$

*11.32 meters*

– or –

$$649,156,897 / 4,370,000 \times (1/4) =$$

*37.14 feet*

## Velocity factor measurement

1. Locate a resonant frequency as described above.

*Example:*

*5 meters (16.4 feet) of open-circuited cable. Resonant frequency is 9400 kHz at the 1/4-wave point.*

2. Calculate the speed of electromagnetic wave in this cable. Divide the length by 1/4, 1/2, 3/4, etc. (depending on the location of the resonant frequency), then multiply by the resonant frequency (in Hz).

$$5 / (1/4) \times 9,400,000 =$$

*188,000,000 meters per second*

– or –

$$16.4 / (1/4) \times 9,400,000 =$$

*616,640,000 feet per second*

3. Finally, find the velocity factor. Just divide the above speed by the electromagnetic constant.

$$188,000,000 / 299,792,458 = 0.63$$

– or –

$$616,640,000 / 983,571,056 = 0.63$$

## Cable fault location

To locate the position of a probable fault in a cable, just use the same method as when measuring its length. Watch the behavior of the reactive component (X) near the zero frequency:

- If the value of X is moving from  $-\infty$  to 0, the cable is open-circuited:

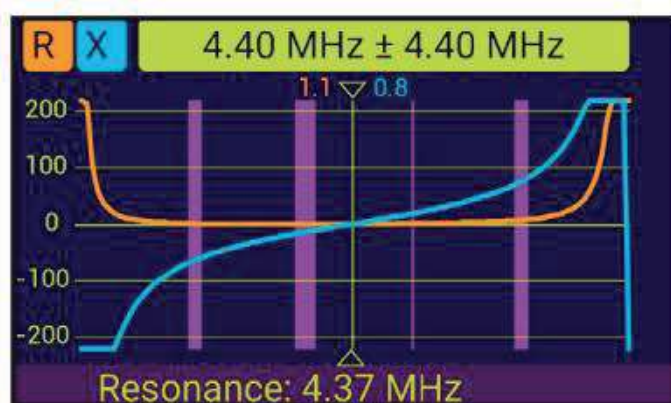

- If the value of X is moving from 0 to  $+\infty$ , the cable is short-circuited:

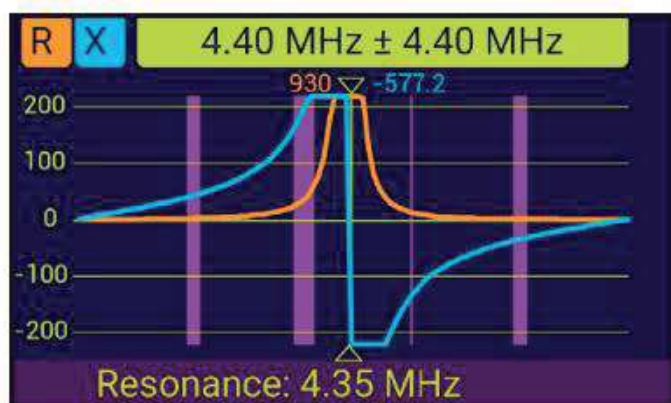

## Making 1/4-λ, 1/2-λ and other coaxial stubs

Pieces of cable of certain electrical length are often used as components of baluns (balancing units), transmission line transformers or delay lines. To make a stub of the predetermined electrical length,

1. Calculate the physical length. Divide the electromagnetic constant by the required frequency (in Hz). Multiply the result by the velocity factor of the cable, then multiply by the desired ratio (in respect to A).

2. Cut a piece of cable slightly longer than this value. Connect it to the analyzer. The cable must be open-circuited at the far end for 1/4-A, 3/4-A, etc. stubs, and short-circuited for 1/2-A, A, 3/2-A, etc. ones.

3. Switch the analyzer to the All parameters measurement mode. Set the frequency the stub is designed for.

4. Cut little pieces (1/10 to 1/5 of the margin) from the far end of the cable until the X value falls to zero (or changes its sign). Do not forget to restore the open-circuit, if needed.

*Example:*

*1/4-λ » stub for 28.2 MHz, cable is RG-58 (velocity factor is 0.66)*

*299,792,458 / 28,200,000 \* 0.66 \* (1/4) =  
1.75 meters*

*– or –*

*983,571,056 / 28,200,000 \* 0.66 \* (1/4) =  
5.75 feet*

*A piece of 1.85 m (6.07 ft) was cut.*

*The margin is 10 cm (0.33 ft). The cable is open-circuited at the far end.*

*28,200 kHz was set.*

*11 cm (0.36 ft) were cut off.*

## Measuring the characteristic impedance

The characteristic impedance is one of the main parameters of any coaxial cable. Usually, its value is printed on the cable by the manufacturer. However, in certain cases the exact value of the characteristic impedance is unknown or is in question.

To measure the characteristic impedance of a cable,

1. Connect a non-inductive resistor to the far end of the cable. The exact value of this resistor is not important. However, it is recommended to use 50 to 100 Ohm resistors.

*Example 1: 50-Ohm cable with 75 Ohm resistor at the far end.*

*Example 2: Unknown cable with 50 Ohm resistor at the far end.*

2. Enter the **R,X** chart mode and make measurement in a reasonably large frequency range (for instance, 0 to 20 MHz).

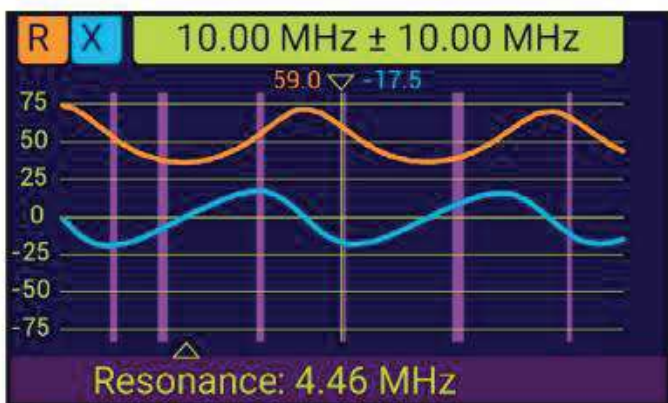

*Example 1:  
50-Ohm cable*



*Example 2:  
Unknown cable*



3. Changing the display range and performing additional scans, find a frequency where R (resistance) reaches its maximum, and another frequency with minimum. At these points, X (reactance) will cross the zero line.

4. Switch to the Data at cursor screen by pressing the **0** (Data) key and find values of R at previously found frequencies.

5. Calculate the square root of the product of these two values.

*Example 1:*

*4.46 MHz – min., 8.92 MHz – max.*

*Example 2:*

*3.47 MHz – max., 716 MHz – min.*

*Example 1:*

*36.2 Ohm – min., 71.6 Ohm – max.*

*Example 2:*

*114.0 Ohm – max, 50.0 Ohm – min.*

*Example 1:*

*square root of (36.2 \* 71.6) = 50.9 Ohm*

*Example 2:*

*square root of (114.0 \* 50.0) = 75.5 Ohm*

*The Tools menu (see page 29) contains several automated tools for coaxial line calculations.*

# Measurement of other elements

Although RigExpert AA-3000 ZOOM is designed for use with antennas and antenna-feeder paths, it may be successfully used to measure parameters of other RF elements.

## Capacitors and inductors

The analyzer can measure capacitance from a few pF to about 0.1  $\mu\text{F}$  as well as inductance from a few nH to about 100  $\mu\text{H}$ . Since measuring of capacitance and inductance is not a main purpose of RigExpert analyzers, the user will have to gain some experience in such measurements.

Be sure to place the capacitor or the inductor as close as possible to the RF connector of the analyzer.

1. Enter the R,X chart mode and select a reasonably large scanning range. Perform a scan.

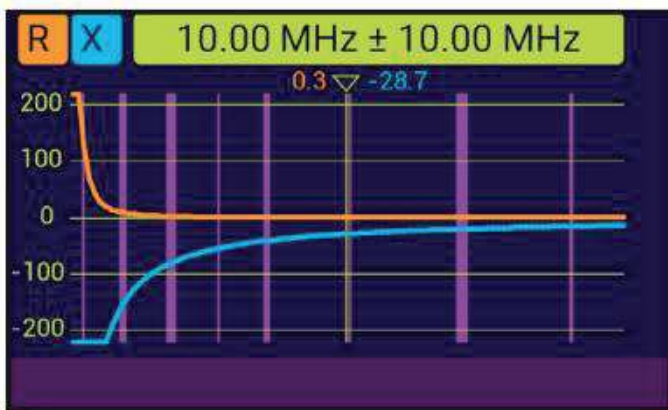

*Example 1:  
Unknown capacitor*

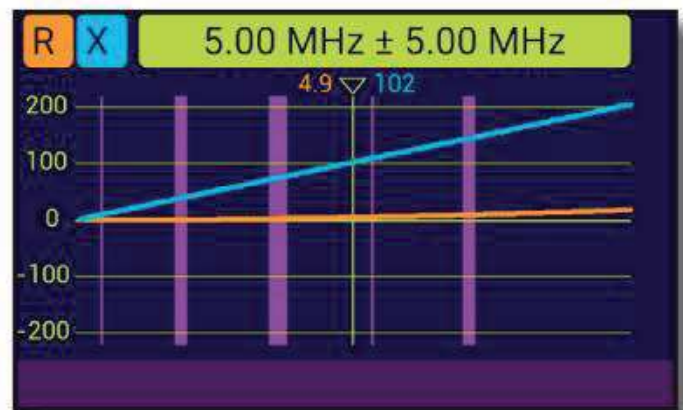

*Example 2:  
Unknown inductor*



2. By using left and right arrow keys, scroll to the frequency where X is  $-25\dots-100$  Ohm for capacitors or  $25\dots100$  Ohm for inductors. Change the scanning range and perform additional scans, if needed.

3. Switch to the Data at cursor screen by pressing the **0** key and read the value of capacitance or inductance.



*Example 1:  
Unknown capacitor*

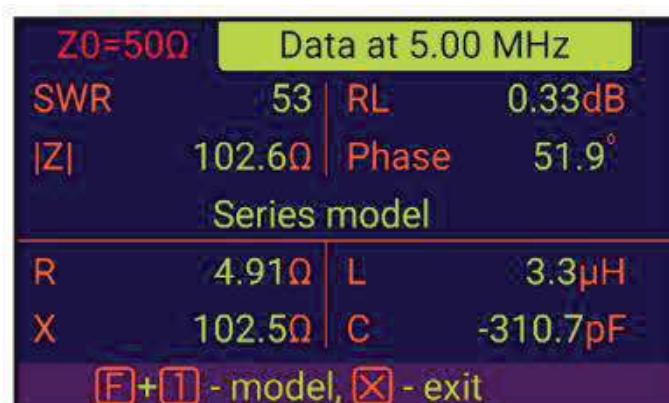

*Example 2:  
Unknown inductor*

## Transformers

RigExpert analyzers can also be used for checking RF transformers. Connect a 50 Ohm resistor to the secondary coil (for 1:1 transformers) and use SWR chart, R,X chart or Smith chart modes to check the frequency response of the transformer. Similarly, use resistors with other values for non-1:1 transformers.

## Traps

A trap is usually a resonant L-C network used in multi-band antennas. By using a simple one-turn wire coil, a resonant frequency of a trap may be measured.

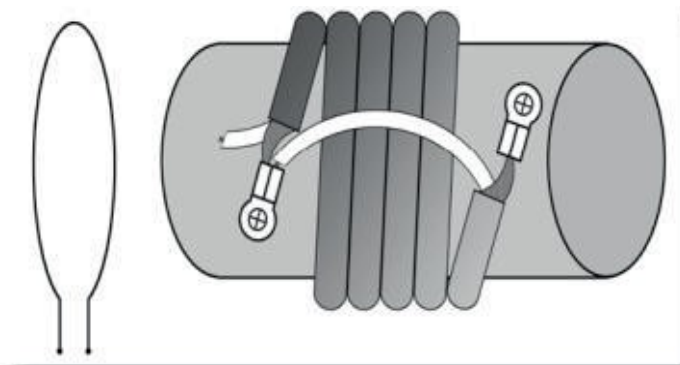

*Example:*

*A coaxial trap constructed of 5 turns of TV cable (coil diameter is 6 cm) was measured.*

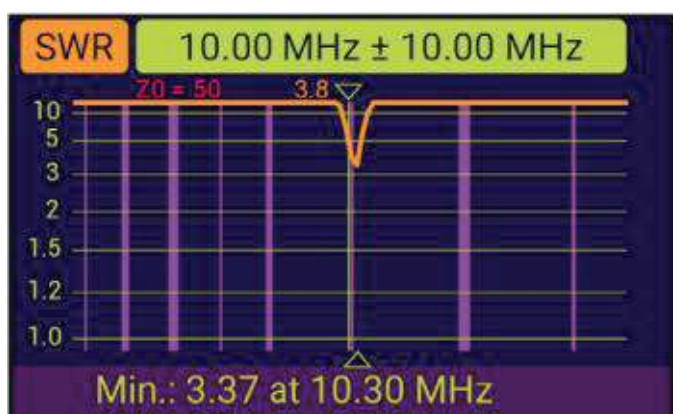

*A one-turn coil (about 10 cm in diameter) connected to the analyzer was placed, co-axially a few centimeters away from the measured trap. The SWR chart shows a visible dip near 10.3 MHz, which is a resonant frequency of the trap.*

**Frequency range:** 0.1 to 3000 MHz

**Frequency entry:** 1 kHz resolution

**Output impedance:** 50 Ohm

**Directivity:** 43db(calibrated)

**SWR measurement range:**

- 1 to 100 in numerical modes
- 1 to 10 in chart modes

**SWR system impedance:** –selectable  
25, 50, 75, 100, 150, 200, 300, 450, 600

**Display modes:**

- SWR at single or multiple frequencies
- SWR, return loss, R, X, Z, L, C at single frequency
- SWR chart
- R, X chart
- Smith chart
- Return loss chart
- TDR chart (Time Domain Reflectometry)
- Cable tools (stub tuner, length & velocity factor, cable loss and characteristic impedance measurement, LC meter, **Multé**)
- **Factory OSL:** Yes
- **User OSL:** 10 profiles available
- **Records:** 250 unified memory slots

**RF output:**

- Connector type: N
- Output signal shape: square
- Output power: –10 dBm (at 50 Ohm load)

## Annex 1 Specifications

**Power:**

- Three 1.5V alkaline batteries, type AA
- Three 1.2V Ni–MH batteries, type AA
- Three 3.7V LiPo batteries, 14200
- Max. 4 hours of continuous measurement, max. 2 days in stand–by mode when fully charged batteries are used
- When the analyzer is connected to a PC or a DC adapter with USB socket, it takes power from these sources

**Interface:**

- 800×480 color Blanview® display
- 6×3 keys on the water–proof keypad
- Multilingual menus and help screens
- USB connection to a personal computer
- Bluetooth Specification v.4.2, LE

**Dimensions:** 98 × 230 × 53 mm  
(3.9 × 9.0 × 2.0 in)

**Operating temperature:** 0...40 °C  
(32...104 °F)

**Weight:** 442 g (15.6 oz)

**Warranty:** 2 years

**Made in Ukraine.**

## Annex 2 Precautions



**Never** connect the analyzer to your antenna in thunderstorms. Lightning strikes as well as static discharge may kill the operator.



**Never** leave the analyzer connected to your antenna after you finished operating it. Occasional lightning strikes or nearby transmitters may permanently damage it.



**Never** inject RF signal or DC voltage into the antenna connector of the analyzer. Do not connect it to your antenna if you have active transmitters nearby.



**Avoid** static discharge while connecting a cable to the analyzer. It is recommended to ground the cable before connecting it.



**Do not** leave the analyzer in active measurement mode when you are not actually using it. This may cause interference to nearby receivers.



If using a personal computer, **first** connect the cable to the antenna connector of the analyzer, **then** plug the analyzer to the computer USB port. This will protect the analyzer from static discharges.

## Annex 3 Tools menu

For the quick access to the the Tools menu, press the **F** + **8** key combination.

### Stub tuner

The Stub tuner mode is designed to help making or checking  $1/4-\lambda$  or  $1/2-\lambda$  coaxial stubs.



Connect either open or short circuited cable to the analyzer and press  (OK) to start.

The analyzer will immediately show resonant frequencies for both quarter-wave and halfwave stubs.

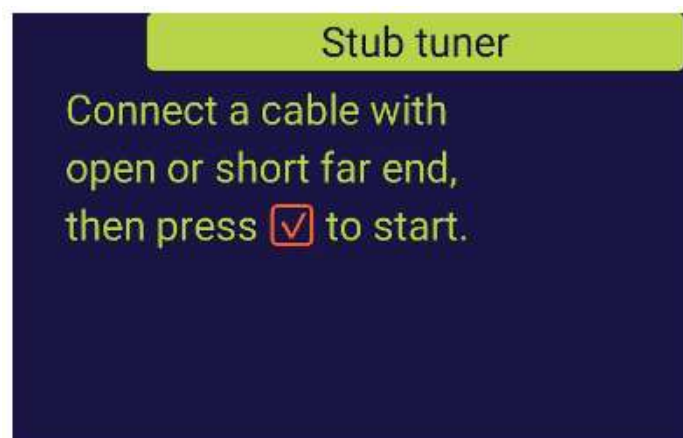

*Longer cables have lower resonant frequency.*

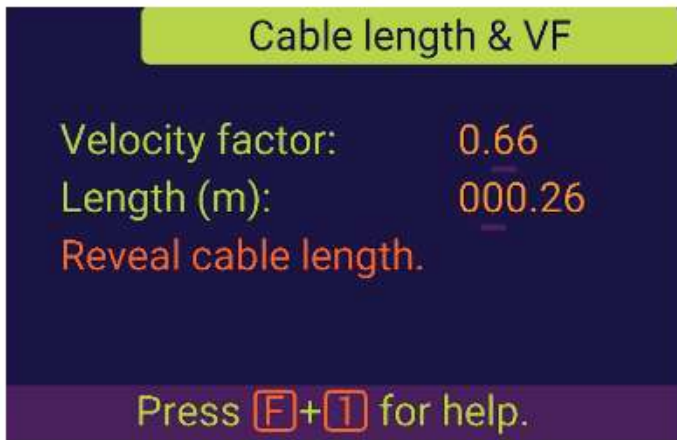

## Length & VF

Knowing the velocity factor, a physical length of a cable can be easily calculated. Press the  (Up) button and edit the value of the velocity factor, then press  (OK) to start measurement.



To find the velocity factor of an unknown cable, press the  (Down) key and enter the physical length, then press  (OK).

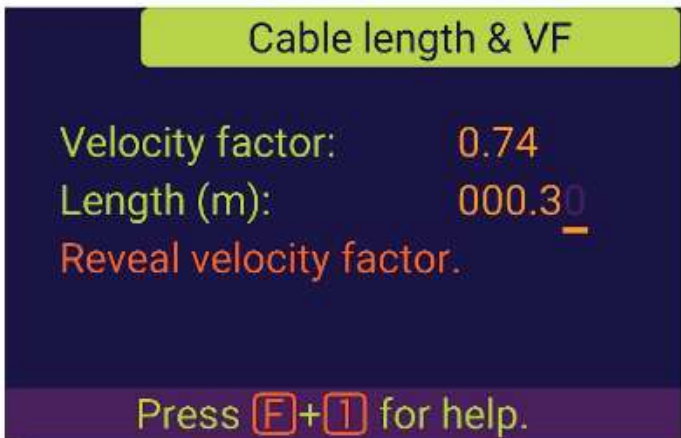

*The velocity factor depends on a type of your transmission line.  
For instance, RG-58 cable with polyethylene insulator has VF=0.66.*



# Cable loss

All measure range is divided for 4 subranges with convenient frequency step. Measure is done as two stage operation. Change of subrange only possible at 1 stage and require full cycle measurement.

Use **3** key to set required subrange, then follow on-screen instructions to perform two stage measurement.

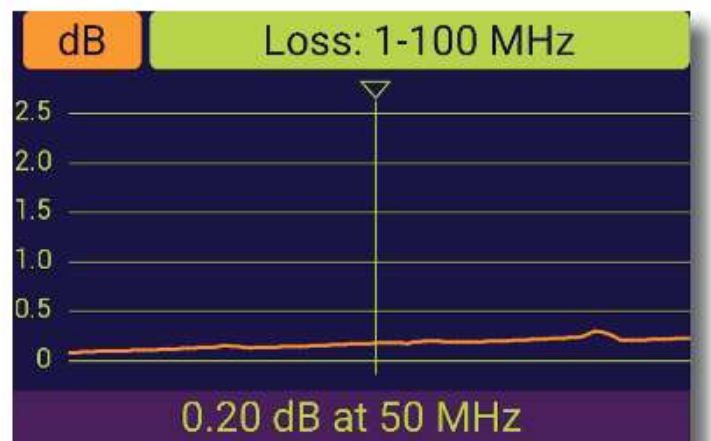
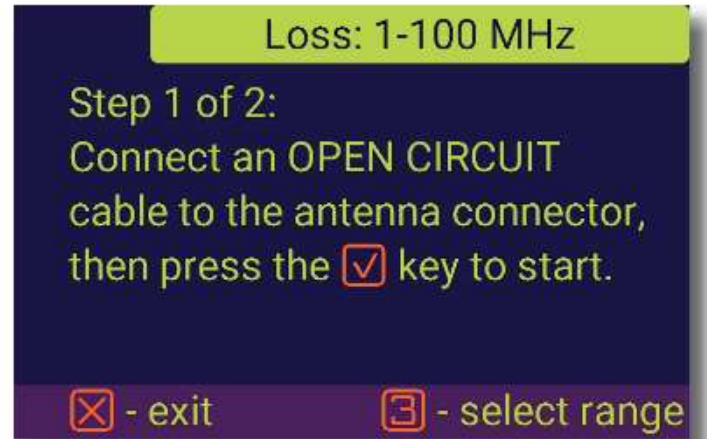

Once the analyzer finishes the measurement, you will see the Loss versus frequency chart. Use **◀** (Left) and **▶** (Right) cursor keys to change frequency and watch the loss value in decibels at the bottom of the analyzer's screen.







## Cable impedance

To measure the characteristic impedance, use a piece of an open circuited cable: a half of a meter (or a foot) or longer should be fine. Press  (OK) to start.

Next, the far end of the cable should be short circuited. Press  (OK) to continue.

There are several reasons why the resulting chart does not look smooth, so we need to use  (Left) and  (Right) cursor keys to find the location where the impedance is stable. The result is shown at the bottom left corner of the screen.

Use  +  (Up) and  +  (Down) key combinations to change the scale, if needed.

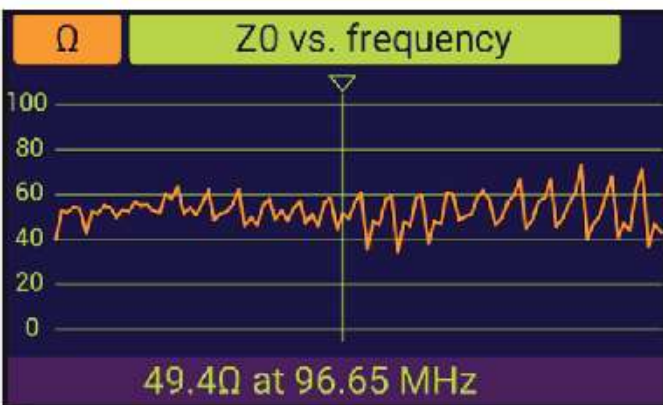
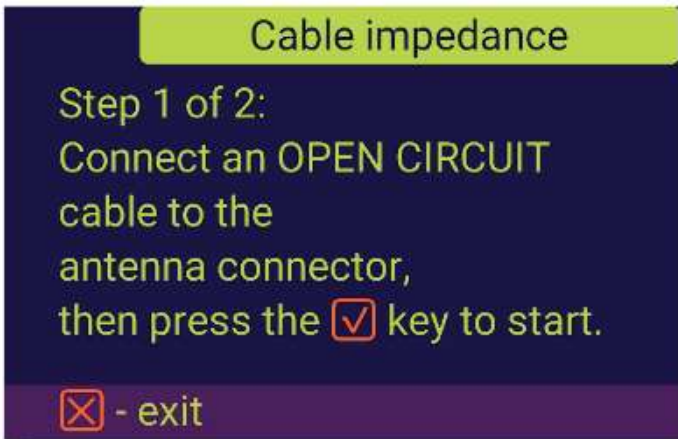



# LC Meter

Use **3** to choose one of six modes (Inductance L, Q,  $\tan \delta$  and Capacitance C, Q,  $\tan \delta$ ), press  to start measure, evaluate result, tune range to most reliable values and restart measure, if required.



Be aware of many factors that will impact result of measure –stray capacitance and inductance, nonuniformities of element connection, more complex behaviour of component at higher frequency.

Avoid pick values at series and parallel resonances (reactance change sign) and adjacent areas, avoid fast changing slopes. Pick values from more stable, persistent areas of chart. In most cases measures at lower frequencies are more reliable.

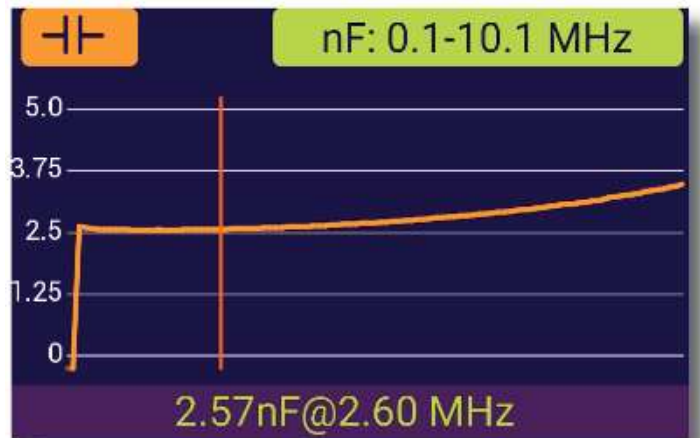

# Self tests

There are several built-in self tests in the AA-3000 ZOOM analyzer, which can be run by the user to make sure the analyzer is working properly. Press  to start the test and then follow instructions given on the display.

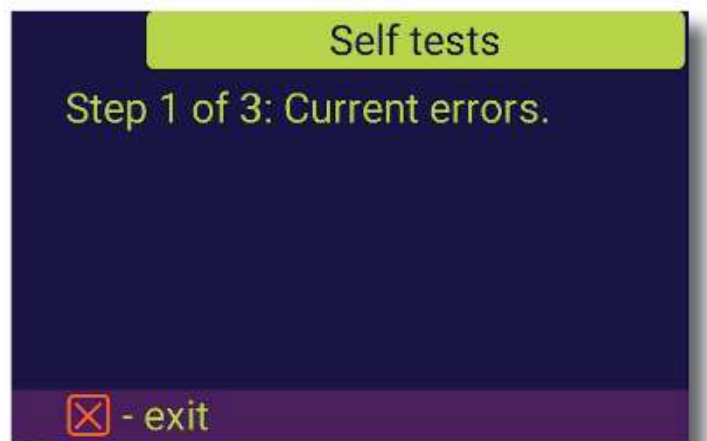

# Annex 4

## Setup menu

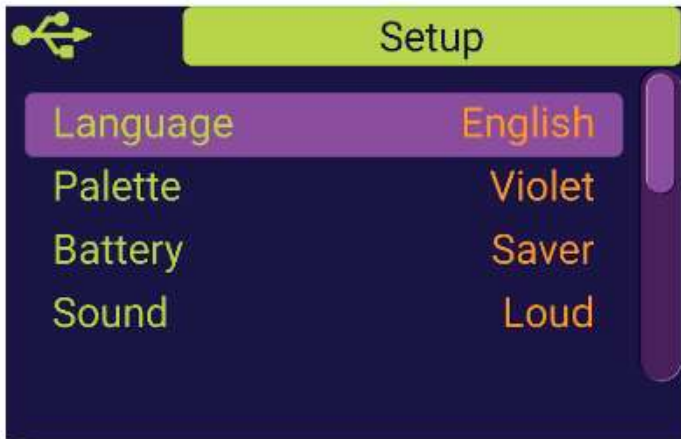

For the quick access to the Setup menu, press the **F** + **3** key combination.

There are several settings in the **Setup** menu:

- **Language** – select a language for the analyzer’s menus
- **Palette** – choose a color scheme
- **Battery** – select a power consumption scheme
- **Battery type** – select a type of batteries
- **Sound volume** – select sound volume
- **Bluetooth** – controls bluetooth module power
- **Sys. imp.** – select system impedance (25, 50, 75, 100, 150, 200, 300, 450, 600 Ohm) which affects SWR and return loss readings.
- **Units** – select metric (meters) or imperial (feet) units
- **Bands** – select region for highlighting of radio amateur bands
- **My Bands** – sub menu for tuning custom bands
- **Cable vel. factor** – choose a velocity factor of the coaxial cable for the TDR mode
- **Freq. corr.** – frequency correction of the analyzer’s oscillator
- **WPM** – setup the Words Per Minute rate (SWR2Air)
- **SWR2Air** – choose the mode of SWR2Air
- **Reset settings** – reset the analyzer to factory defaults
- **Clear saved charts** – clear all memory slots

## Theory

Time domain reflectometers (TDR) are electronic instruments used for locating faults in transmission lines.

A short electrical pulse is sent over the line, and then a reflected pulse is observed. By knowing the delay between two pulses, the speed of light and the cable velocity factor, the *DTF* (distance-to-fault) is calculated. The amplitude and the shape of the reflected pulse give the operator idea about the nature of the fault.

Instead of a short pulse, a “step” function may be sent over the cable.

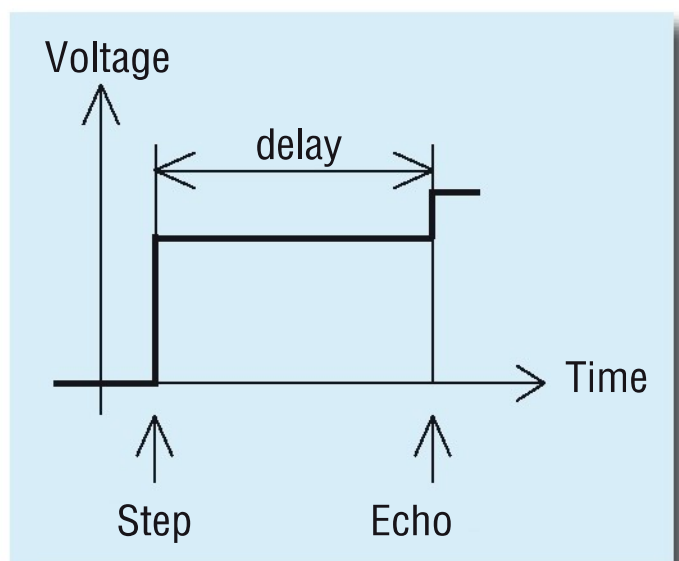
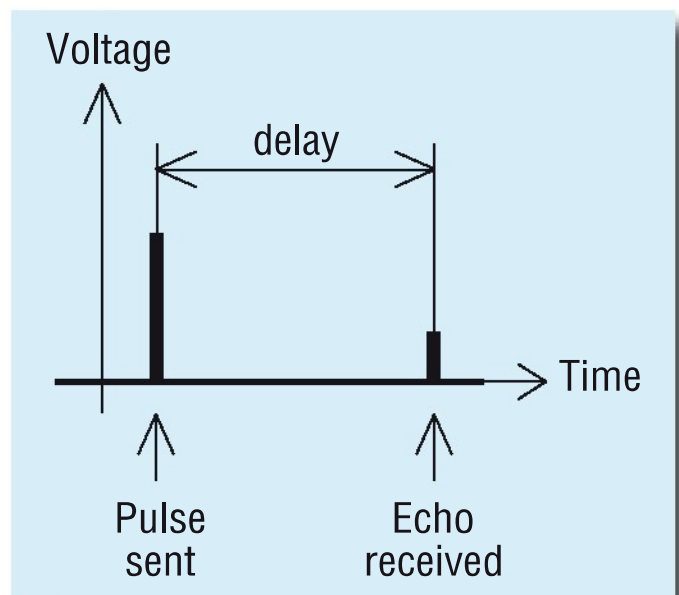

Unlike many other commercially-available reflectometers, RigExpert AA-3000 ZOOM does not send pulses into the cable. Instead, another technique is used. First, R and X (the real and the imaginary part of the impedance) are measured over the whole frequency range (up to 3000 MHz). Then, the IFFT (Inverse Fast Fourier Transform) is applied to the data. As a result, impulse response and step response are calculated. This method is often called a “Frequency Domain Reflectometry”, but the “TDR” term is used in this document since all calculations are made internally and the user can only see the final result.

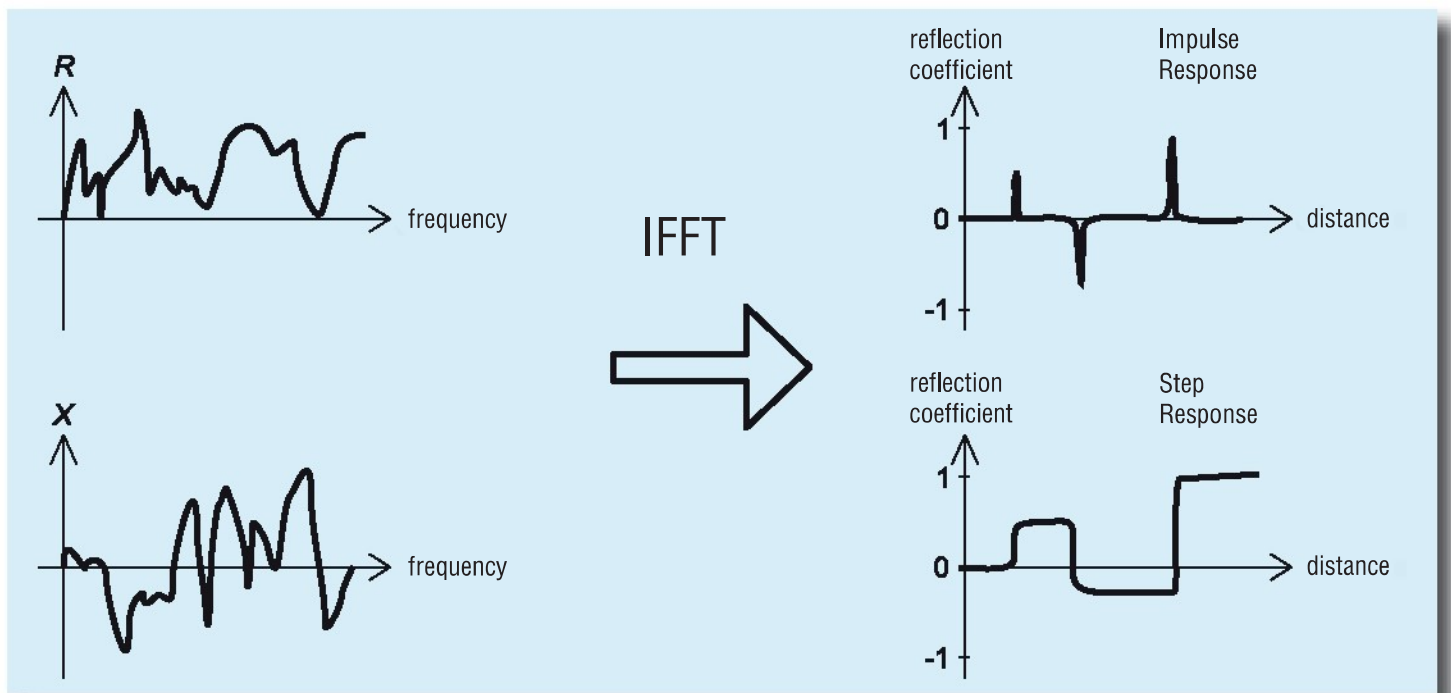

The vertical axis of the resulting chart displays the reflection coefficient:  $\Gamma = -1$  for short load, 0 for matched impedance load ( $Z_{Load} = Z_0$ ), or +1 for open load. By knowing the cable velocity factor, the horizontal axis is shown in the units of length.

Single or multiple discontinuities can be displayed on these charts. While the Impulse Response chart is suitable for measuring distance, the Step Response chart helps in finding the cause of a fault.

See the examples of typical Step Response charts on the next page.

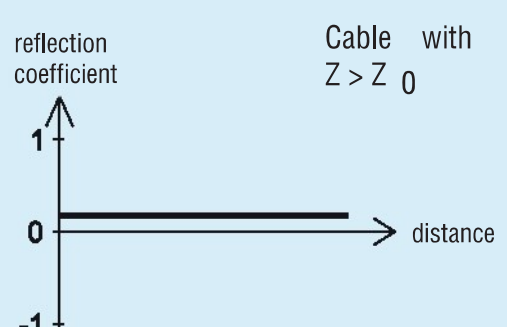
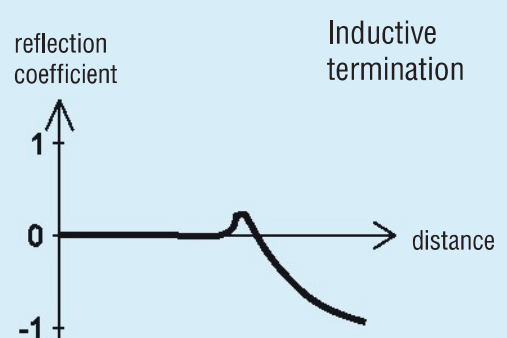
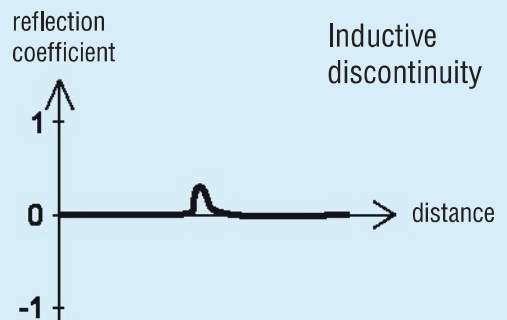
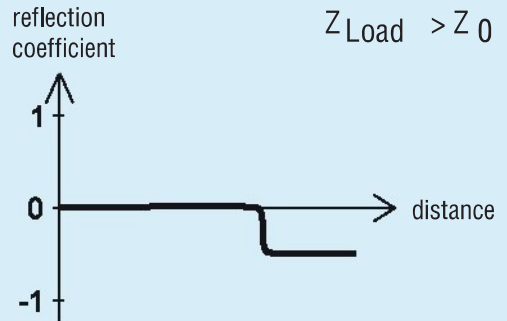
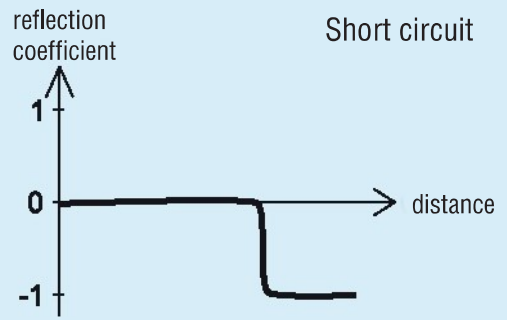
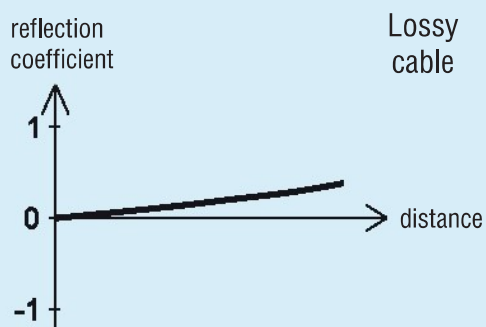
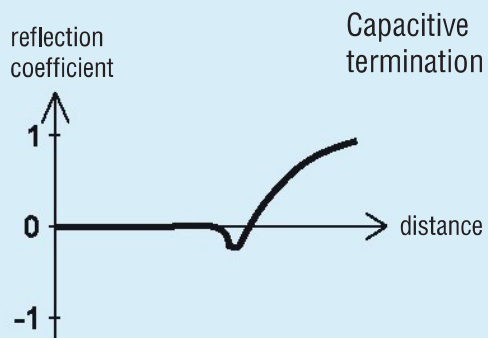
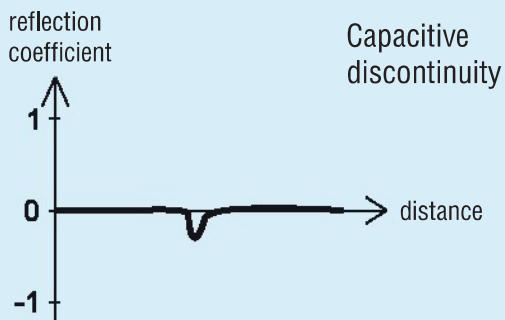
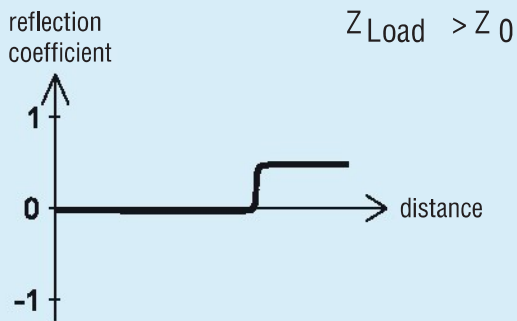
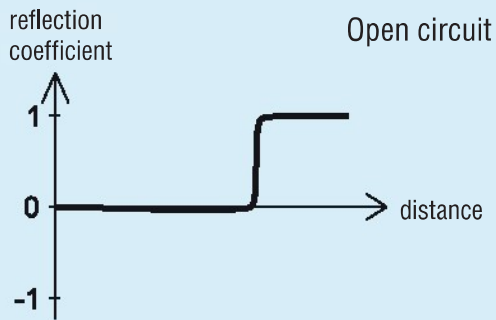

## Practice

Use **3** for quick setup popup, choose smallest range appropriate for your cable length (shorter distances have better length resolution), tune velocity factor fast. Change of velocity factor corrects range distances.

The result of measure can be viewed in three modes: impulse response, step response, impedance response. To switch view press **F** + **3**, use **0** for numerical representation all data at marker. Three pictures there show real measure of short open stub in different view modes. Explore built-in help for other buttons functionality.

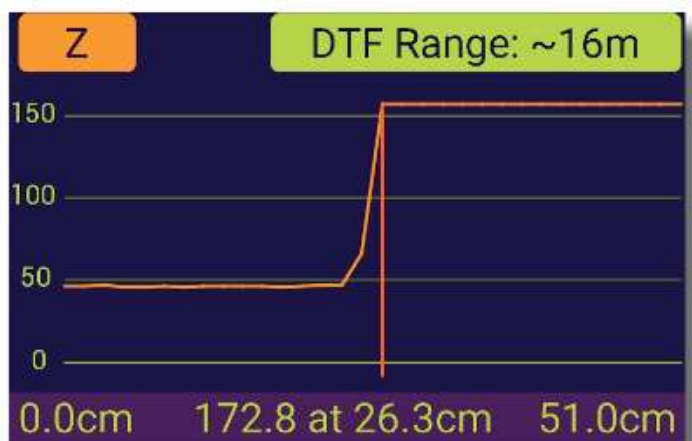
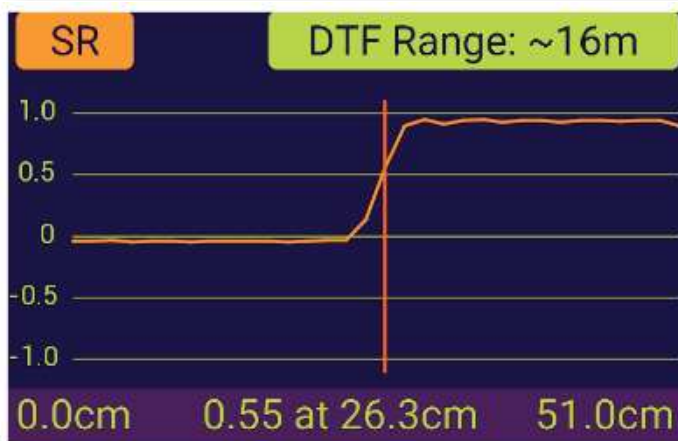

## Annex 5 TDR mode

RigExpert AA-3000 ZOOM is designed for high performance and uses factory open-short-load (OSL) calibration. To make usage more flexible for experienced users there are 10 user OSL profiles, that can be applied above factory OSL.

The standards used for calibration should be of high quality. This requirement is especially important for high frequencies (100 MHz and upper). Three different calibration standards should be used: an “open”, a “short” and a “load” (50 Ohm OSL kit). A place where these standards are connected during calibration is called a reference plane. If the calibration is done at the far end of a transmission line, parameters of this line will be subtracted from measurement results and the analyzer will display “true” parameters of a load.

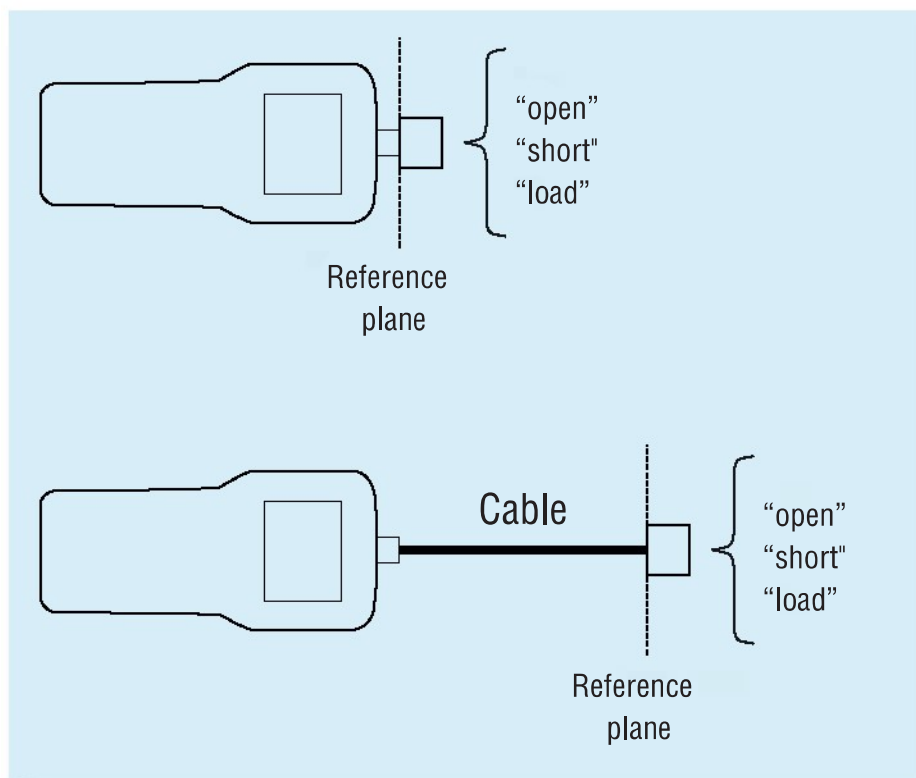





Use **F** + **2** in main menu to go in calibration profiles management screen. Select profile and press **✓** to make profile active, combination of **F** + **✓** allows to edit existing profile name.

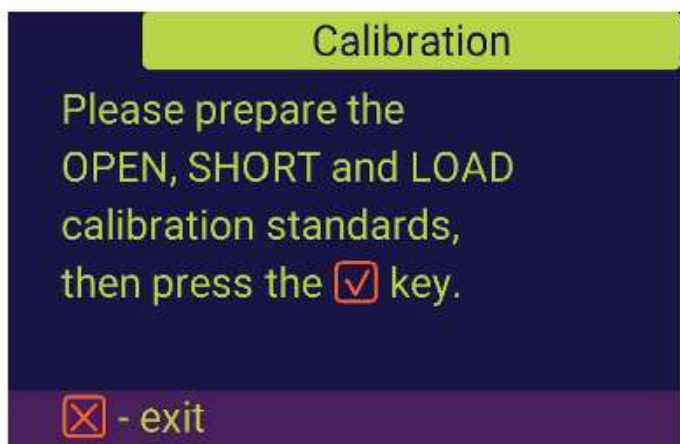

Key **▶** starts calibration sequence for selected profile. Follow instructions on screen to perform 3 step calibration.

*You may connect calibration standards to the far end of a cable, so the cable will be "nulled".*

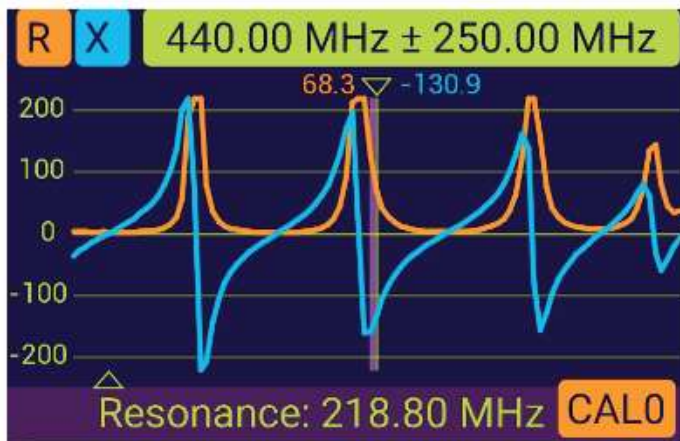

To apply calibration, press the **F** + **2** key combination in any measurement mode. The small "CALn" mark will appear on screen, where n is number of active profile(0..9)



Amphenol  
202109-10  
1 Watt  
terminator plug.  
**Low SWR.**



50 Ohm dummy loads are not all equal. For calibration (see page 32), please use low-power RF terminators which provide low SWR over the wide frequency range. High-power terminators, with cable or not, are suitable neither for calibration purposes (page 32), nor for analyzer self-tests (page 30).

# Annex 7 Dummy loads

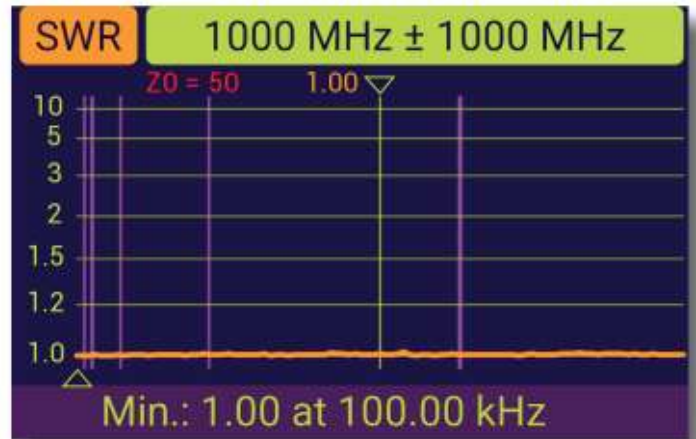

Bird 8201  
500 Watt oil-cooled termination  
**High SWR**

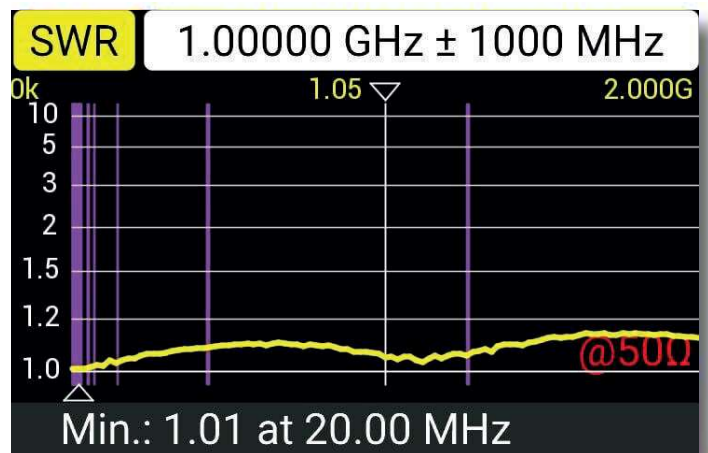

**EC DECLARATION OF CONFORMITY**  
**In accordance with EN ISO 17050-1: 2004**

We, Rig Expert Ukraine Ltd. of 2 Solomenska Ploscha, Kyiv, 03035, Ukraine Declare under our sole responsibility that the product:

Equipment	<b>Antenna and cable analyser</b>
Brand name	<b>RigExpert</b>
Model number	<b>AA-30000 ZOOM</b>

to which this declaration relates, is in conformity with the following standards and / or other normative documents:

Reference No.:	Title:	Edition / Date:
IEC 61000-4-2	Testing and measurement techniques – Electrostatic discharge immunity test	2009
IEC 61000-4-3	Testing and measurement techniques – Radiated, radio-frequency, electromagnetic field immunity test	2006

We hereby declare that the above named product is in conformity to all the applicable essential requirements of directive 2004/108/EC (the EMC Directive).

The technical documentation relevant to the above equipment will be held at:

**SEDAM Communications Limited**

**Old Mill Cottage, Shillington Rd, Gravenhurst, MK45 4JE, The United Kingdom**

/Ashot Andrieiev/

June 23,2020

Director



### **For private households: Information on Disposal for Users of WEEE**

This symbol on the product(s) and / or accompanying documents means that used electrical and electronic equipment (WEEE) should not be mixed with general household waste. For proper treatment, recovery and recycling, please take this product(s) to designated collection points where it will be accepted free of charge.



Alternatively, in some countries, you may be able to return your products to your local retailer upon purchase of an equivalent new product. Disposing of this product correctly will help save valuable resources and prevent any potential negative effects on human health and the environment, which could otherwise arise from inappropriate waste handling.

Please contact your local authority for further details of your nearest designated collection point . Penalties may be applicable for incorrect disposal of this waste, in accordance with your national legislation.

### **For professional users in the European Union**

If you wish to discard electrical and electronic equipment (EEE), please contact your dealer or supplier for further information.

### **For disposal in countries outside of the European Union**

This symbol is only valid in the European Union (EU). If you wish to discard this product, please contact your local authorities or dealer and ask for the correct method of disposal.

<http://www.rigexpert.com>

Copyright © 2020–2022 Rig Expert Ukraine Ltd.

“RigExpert” is a registered trademark of Rig Expert Ukraine Ltd.



Doc. date: 11–May–2023