

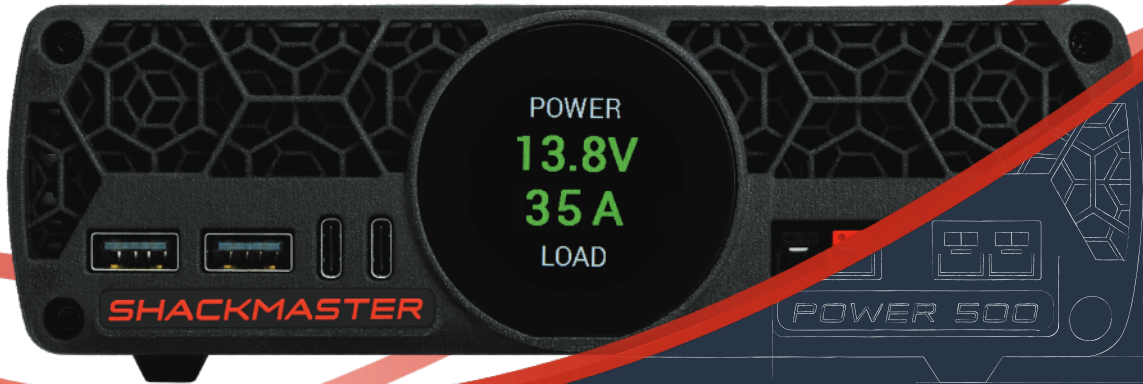

POWER 500 POWER SUPPLY

Instruction Manual



POWERED BY

RigExpert

- DEADLY QUIET
- HIGHLY EFFICIENT
- LIGHTWEIGHT AND COMPACT
- EXPEDITIONS COMPATIBLE
- TOLERANT TO GASOLINE GENERATORS
- SAVES WORKSPACE DUE TO FLEXIBLE ORIENTATION

POWER 500 POWER SUPPLY

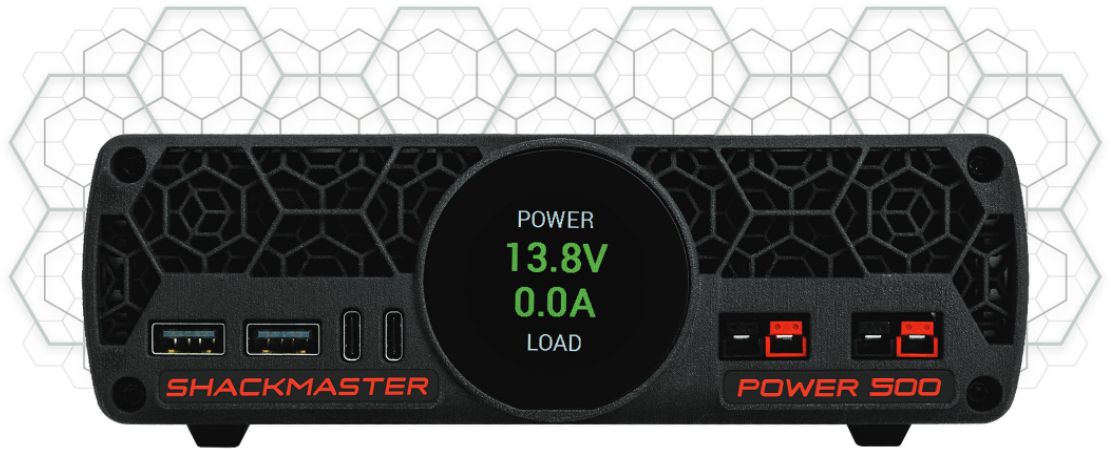

For latest manuals and software updates, please visit

rigexpert.com

Introduction	4
Product Registration	7
Safety considerations	7
Specifications	8
Part Names & Functions	9
Confirm Package Content	9
Installation	10
First Power-Up	12
Operation	14
Touch Panel Usage	14
Powering Device Up	15
Display Control	16
Intelligent Protection System	17
Service Functions	19
Precautions	27
DECLARATION OF CONFORMITY	29

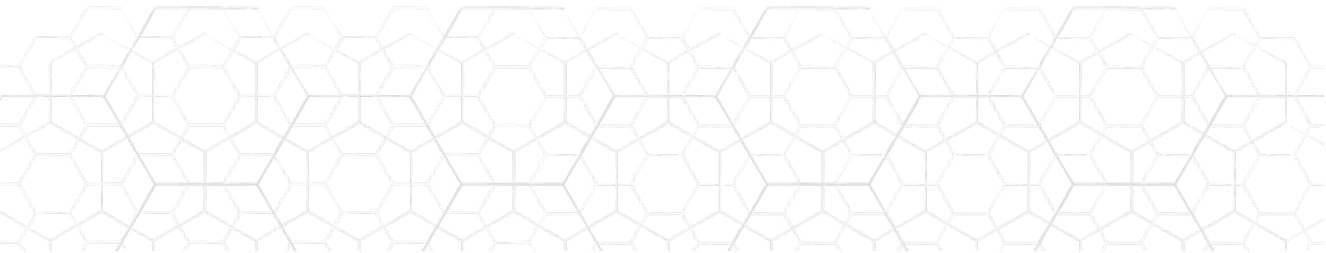

Congratulations on purchasing our **Shackmaster™ Power 500** 35A|13.8V Power Supply. **Rig Expert Ukraine Ltd.** is pleased that you have chosen one of our products, and we will endeavor to provide you with the information and support you need to enjoy your purchase for many years. We urge you to read all of the following materials before you start operating your new power supply.

This wonderful power supply is designed to suit your needs as it:

- **Ensures consistent and reliable power supply** to your devices and maximizes the life of overload-sensitive devices.
- **Protects** your equipment from overcurrent, overvoltage, and overheating.
- **Minimizes** electromagnetic interference and acoustic noise.
- **Ensures ergonomics** of your workspace due to vertical or horizontal installation.
- **Provides power** for demanding tasks and power-intensive setups.
- **Offers a variety of ports** for connecting various gears.
- **Charges** devices, connects peripherals, or powers USB-compatible gadgets.
- **Monitors** voltage, current, and power consumption in real-time.
- **Lets you log and analyze** consumption data.
- **Runs flawlessly in DXpeditions** thanks to its tolerance to gasoline generators, wide operating temperature range and internal power consumption logger.

Shackmaster™ Power 500 Power Supply is the High-Quality DC power supply **designed to ensure stable 13.8V | 5V voltage for the following use for:**

13.8V HF and VHF transceivers, amateur radio accessories like VHF, UHF and microwave transverters.

Low Noise HF and VHF preamplifiers, antenna rotator controllers, control and RF antenna relays, etc.

Amateur radio

Telecom Equipment

PoE systems

Laboratory Equipment

Do It Yourself projects

Mechanical & electrical equipment

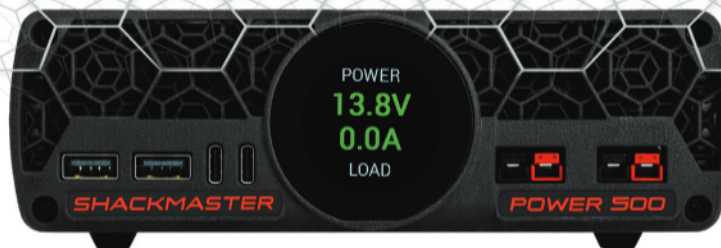

SHACK MASTER

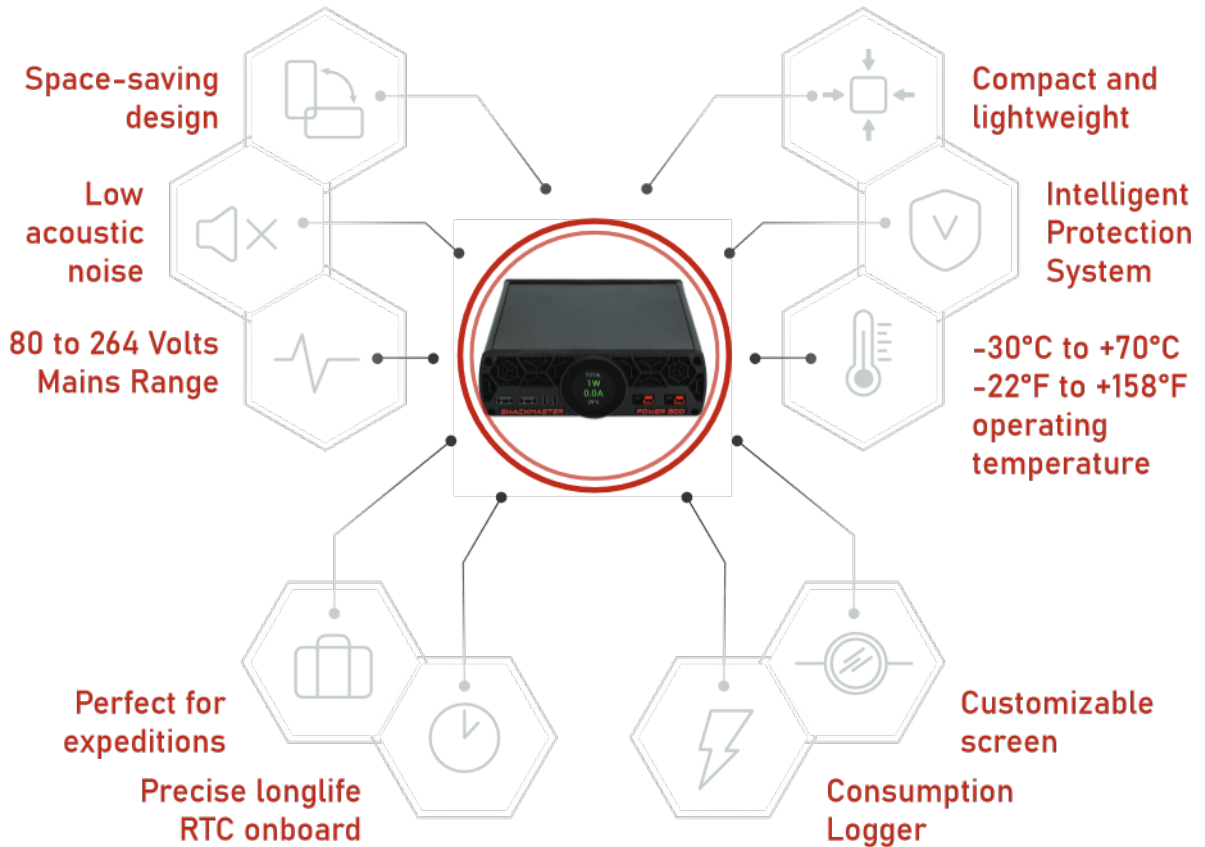

Product Registration

Registration brings benefits.

You will get significant benefits with **RigExpert Club**:

- Additional 1 year replacement warranty from RigExpertCare
- Product software updates by email
- Special promotions and offers
- Chance to win a gift certificate

To take part in a new support program you should use inside the box the **RigExpert Club** card. To join the club you just have to register your new device:

- Scan QR-code on the Club card with a smartphone/tablet > You can see a Registration form > Fill it down > You will get a notification: «Congratulations! You have joined the RigExpert Club»

Safety Considerations

The Shackmaster™ Power 500 Power Supply is a Safety Class I unit.

The grounding lead (yellow with 2 green stripes) of the power cable must be connected to the station's grounding system for safe operation.

The power supply is designed to meet international safety standards and complies with CE safety and electromagnetic compatibility requirements, as well as FCC regulations.

This operating manual contains a number of precautions and warnings that **MUST BE FOLLOWED BY THE USER** to ensure the safe operation of the power supply.

Use the AC cable delivered with this unit.

Computer power cords with C13 connector are compatible as well.

Specifications

Rated power	500W
Rated current	35A
Output voltage	13.8V
Ripple	200mVp-p
Input AC voltage	80V to 264V
Input AC frequency	47Hz to 63Hz
AC current (maximum)	5.8A @ 110VAC 2.9A @ 230VAC
Overvoltage protection	Yes
Overvtemperature protection	Yes
Overcurrent protection	Yes
Short circuit protection	Yes
Working temperature range	-30°C to +70°C -22°F to 158°F
Storage temperature range	-40°C to +85°C -40°F to 185°
EMC Emission	Class I: Class B, Class II: Class A
Dimension	172mm x 55mm x 185mm
Weight	1.1kg
Acoustic noise	~21 dBa

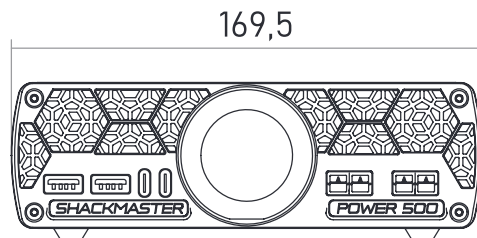
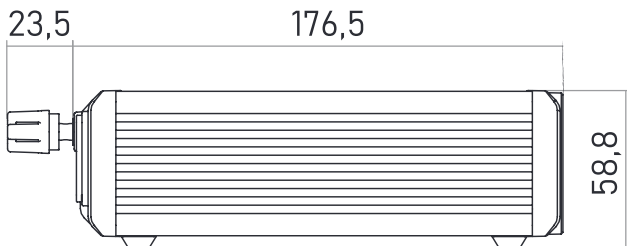
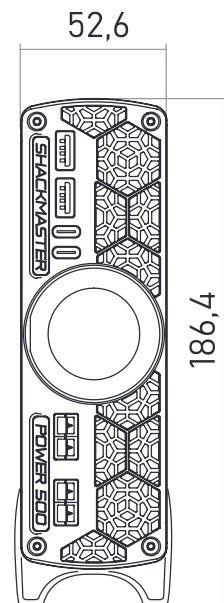

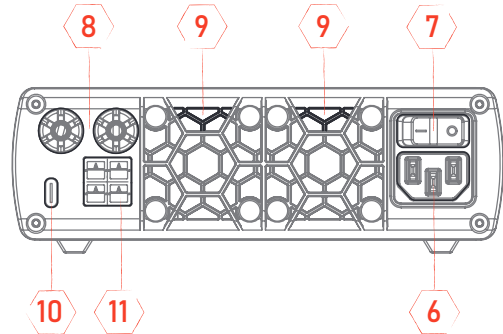
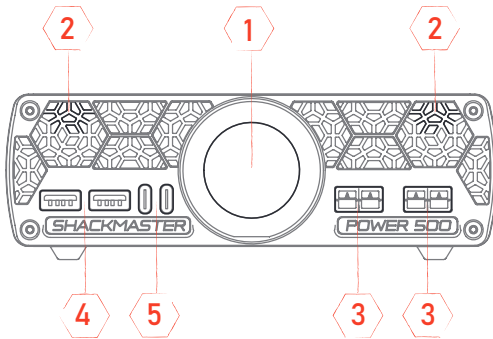

- 1 240x240 Color TFT LCD with Capacitive Touch Panel
- 2 Cooling System Intake
- 3 45A Anderson Powerpole Connectors
- 4 USB A Charging Ports
- 5 USB Type-C Charging Ports

- 6 Mains Power Entry
- 7 Mains Line Switch
- 8 30A Binding Post
- 9 Fan Outlet (Exhaust)
- 10 Type-C PC Communication
- 11 15A Anderson Powerpole Connectors

Confirm Package Content

- Shackmaster™ Power 500 Power Supply
- AC power cable
- User manual
- USB cable for computer control
- Four silicon feet

THE MANUFACTURER CAN
CHANGE THE CONTENTS
WITHOUT FURTHER NOTICE.

Installation

Before plugging the **Shackmaster™ Power 500 Power Supply** into an AC outlet, make sure that the mains voltage is within the 80 to 264V AC range.

For user convenience this power supply can be placed horizontally or vertically on the special stands as shown on the picture.

For vertical position the special stand is used.

In this case the silicon stands are not needed.

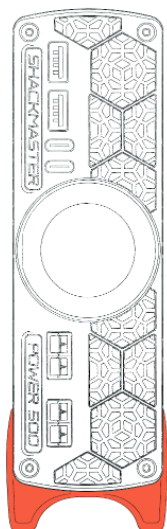

If the unit is placed horizontally use four silicon feet.

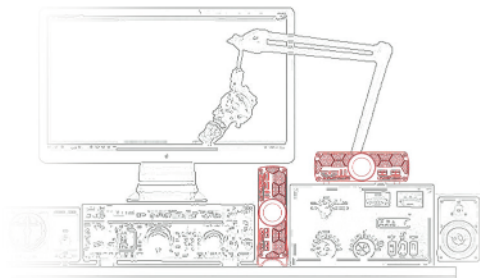
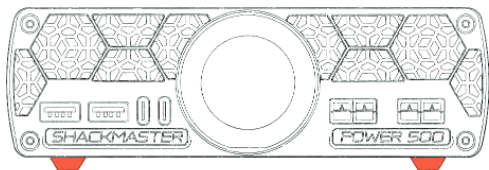

Two 5V USB Type A and two 5V USB Type C connectors are at the bottom-left corner of the front panel and can be used for charging.

The Anderson Powerpole® Connectors are at the bottom-left corner.

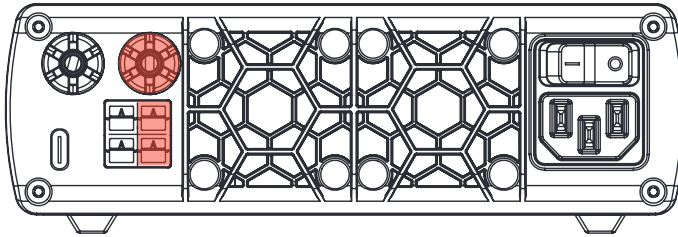

The loads can be connected also to Anderson Powerpole® connectors at the rear panel. There are additional connectors at the rear panel of the power supply:

- one USB Type C connector for PC connection
- 1x Binding 13.8V post

Anderson Powerpole® and Binding posts are color coded as:

Red - + (plus 13.8V), **Black** - - (minus 13.8V)

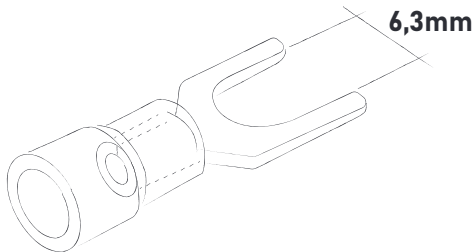

It is recommended to connect the load to the binding posts by Fork spade terminals.

The main power switch is at the right-top corner of the rear panel.

Before you perform the first power-up, make sure your setup complies with the safety requirements outlined below.

WARNING

General safety precautions below must be followed in each phase of the power supply operation. In case of failure to follow these precautions or specific warnings in other parts of the manual is considered as violation of the safety standards related to the design, manufacture and intended use of the instrument. If the user does not follow these precautions, the Manufacturer will be held not responsible for any consequences.

- The Power 500 can only be used indoors or in low condensation areas. The general environmental requirements are stated in the Specifications section.
- To avoid accidental injury, the power cord supplied by the manufacturer only must be used.
- The Power Supply is provided with a three-core power cord that should be connected to a three-core outlet which is properly grounded. Before operation, make sure that the Power 500 is well grounded.
- Use electric wires of appropriate load. All loading wires should be capable of bearing maximum short-circuit of electronic load without overheating.

- To prevent burnout, please pay special attention to positive and negative polarities of electronic load during connection!
- Do not use damaged equipment. Please check the housing before using the equipment. Check whether the device has cracks or lacks plastic.
Do not operate the power supply in the environment with explosive gas, steam or dust.
- Do not install alternative parts on the instrument or perform any unauthorized modification.
- We do not assume responsibility for any direct or indirect financial damage or loss of profit that might occur when using the power supply.
- Do not use the equipment on the life support system or other equipment with / safety requirements.

CAUTION

- Reduce the load if the built-in protection system displays a warning to reduce the power consumption.
- Always use dry cloth to clean the Power Supply housing.
Do not clean the inside of the instrument.
- Do not block the air vent of the Power Supply.

Touch Panel Usage

The device is equipped with a multifunctional color display with a touch panel. The touch panel is used to turn the device on and off, as well as to control display modes. To interact with the touchpad, the so-called gestures are used:



Tap



Long Press



Swipe Up



Swipe Down



Swipe Right



Swipe Left

The panel distinguishes several gestures: tap, long touch and swipe.



Some modes use a sequence of gestures. For example, swipe and tap go sequentially one after another.



To tap, touch lightly the screen with the tip of your index finger and lift it again, quickly. The touch lasts only a fraction of a second for the screen to respond, no need to press it hard.



A **long press (press-and-hold)** is done when you touch the screen and hold your finger on the same spot. This gesture is also called «press and hold» and can be used to activate special menus or switch power supply off/on quickly.

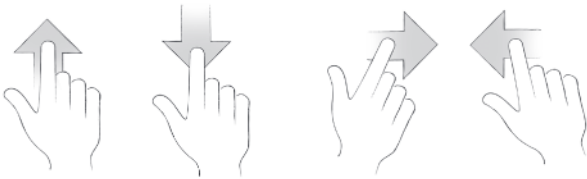

A **swipe** is done when you touch and slide your finger across the screen.

You can swipe quickly or slowly.

The device distinguishes between **swiping up, down, left and right**.

Powering Device Up

Once you have completed all the preparations, you can turn the Main Switch on the rear panel to position "I". After that, the device will go into Standby Mode turning on the screen for a short time to show the Device Serial Number.

By default, the device is configured to be Switched On / Off by a Swipe gesture or a Long Press gesture.

Later, you can change these and other settings yourself using the REAMP companion software.

To Turn device ON quickly use a Long-Press gesture.

To Turn device OFF quickly, also use a Long-Press gesture.

Display control

Controlling the display

Press the power switch ON at the top-right corner of the rear panel to turn on the power supply. The orange welcome message shows up on the round front panel LCD touchscreen. The next step is to swipe along the round front panel LCD touchscreen, and the following message: **SWIPE TO SWITCH ON**

Instantly swipe the screen once more and the following message: **TOTAL 0W 0.0A 29C** will appear.

When the load is connected to any of the 13.8V terminals, the display shows both the consumed power and current: **50W 3.60A 29C**

Touching the screen once again brings up the next screen: **POWER 14.0V 3.60A LOAD**

The next touching the screen brings up the next screen: **AUX 5.1V 0.00A USB C** that shows the voltage and consumed current at 5V Type A and Type C connectors.

By touching the screen again, we get the next message: **CONDITIONS 209V +23C** showing the mains voltage and the temperature directly next to the Air Intake.

Another touch brings back the first screen: **TOTAL 0W 0.0 A 29 C**

To switch the power supply OFF use Swipe gesture to get the following message: **SWIPE TO SWITCH OFF**

Swiping once more, to switch the power supply off.

The following automatic functions can be controlled by the software:

- automatic power-off if inactivity is longer then determined of inactivity;
- automatic ON/OF switching at the determined time set;
- automatic switching back ON in case of mains failure.

The RigExpert REAMP software can be used to adjust and tune the display.

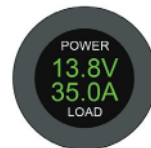

The main task of this system is to keep the user informed at all times to make the use of the device use comfortable and safe.

The intelligent protection system is a state machine that, depending on the parameters of the load, the mains, and the air temperature, provides power consumption control and, in case of adverse conditions, warns the user that power consumption should be limited to avoid damage of the Power Supply.

The power supply delivers maximum rated power if the input voltage is in the range from 115 to 260 Volts and the room temperature is not higher than 104 °F (40 °C). We consider this wide enough range of voltages and temperatures to be ideal operating conditions. In all other cases, the maximum permissible value of power consumption is less than the nominal value and depends on the conditions. Therefore, if the current conditions are not ideal and power consumption is close to the maximum, the protection system will gently notify you about this and ask you to reduce consumption.

For example, with a mains voltage of 80 Volts and at +70 °C air temperature in the room of +70 °C, the maximum output power will be limited to 300 W, and the user will be warned about it.

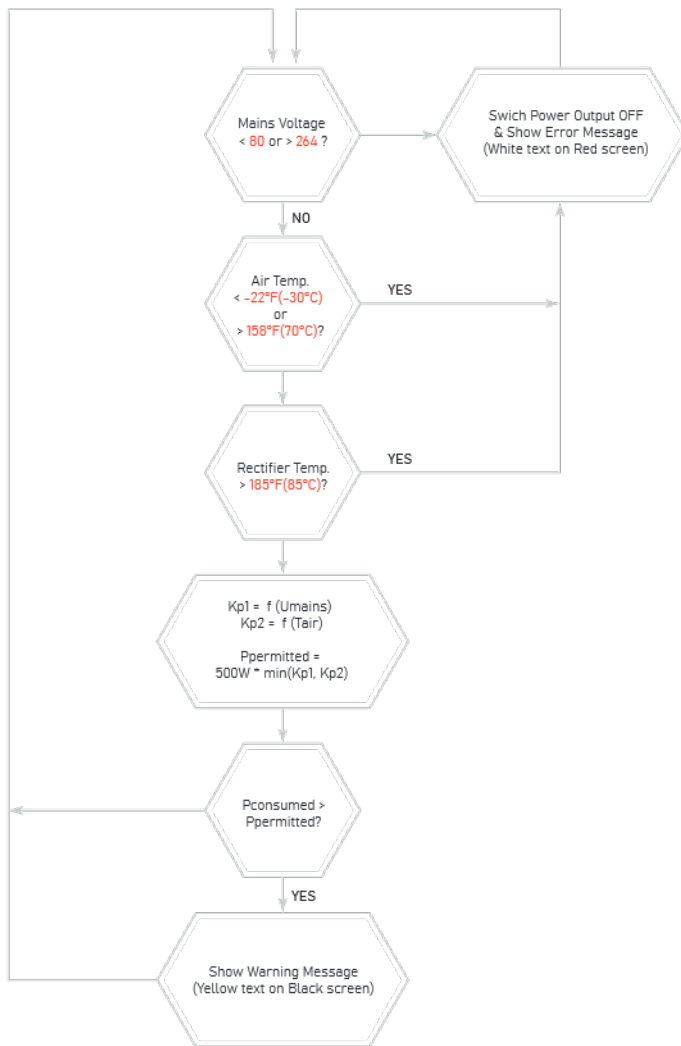

The power supply has an interface with a computer, that provides you with additional capabilities of device control and its condition monitoring, namely:

- The special companion PC software to log consumption and auxiliary data both for USB and Anderson Powerpole® Connectors during the operation of the power supply.
- USB interface to log consumption data and update firmware.

The following automatic functions can be controlled by the software:

- automatic power-off if inactivity is longer then determined of inactivity;
- automatic ON/OFF switching at the determined time set;
- automatic switching back ON in case of mains failure.

The RigExpert REAMP software can be used to adjust and tune the display.

Installing REAMP Logger software

The RigExpert® REAMP Logger software enables you to control the Power 500 power supply remotely via USB interface. This instrument enables you to record all aspects of the operation of the Power 500 supply over a long period of time and subsequently analyze the accumulated data subsequently.

To get software please use link

<https://rigexpert.com/products/reamp-logger/reampsw/>

The setup program installs the REAMP Logger software on PC's running Windows, MacOS and Ubuntu 21.10 operation systems.

To install the software, download the latest software installer from the REAMP Logger product homepage <https://rigexpert.com/products/reamp-logger/reampsw/>

Connecting the Power 500 to the PC

To connect Power 500 to your PC please use the cable delivered with the device. You can also use any high-speed USB cable with a USB A connector on one side and USB Type-C on the other side.

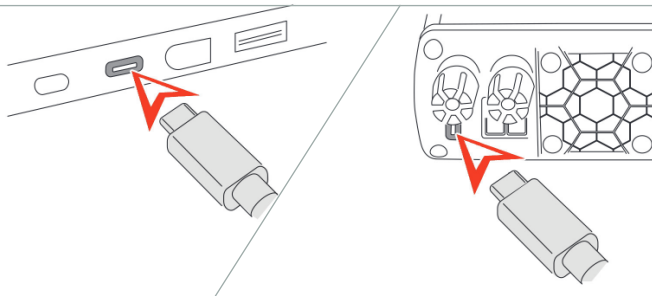
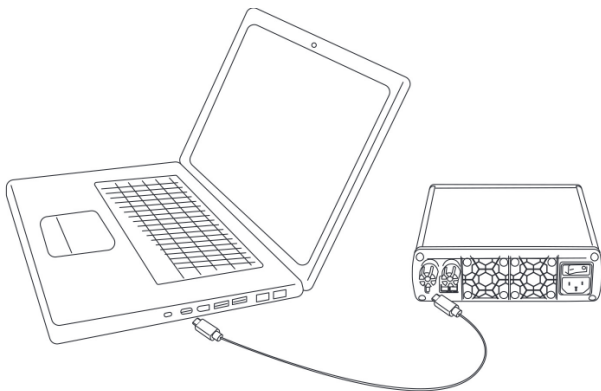

REAMP Logger screen layout

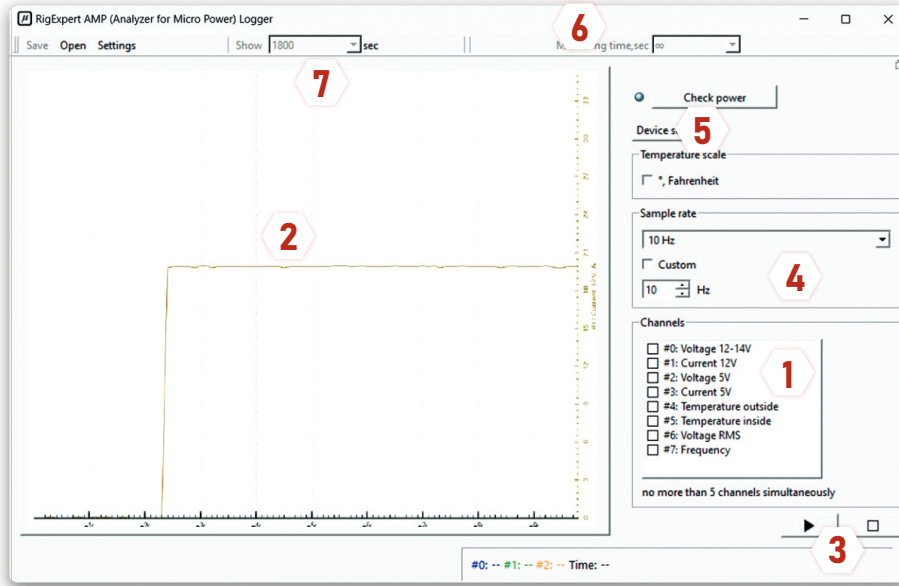

- 1** Recordable Parameters measured by the device
- 2** Sampled Data Representation
- 3** Start / Stop Logging controls
- 4** Sample Rate Controls
- 5** Device Configuration Tools
- 6** Logging interval
- 7** Display interval (Display window width in seconds)

Logging Process

When REAMP Logger software communicates with the Power 500 power supply the software is in measurement mode. The measurement mode (logging) is the operating mode which displays instantaneous sampling of the measured value digitized and shown in the form of a graph on the screen and saves data to a log file.

Several parameters can be recorded and displayed simultaneously using the controls. You can also set length of the period when these parameters will be recorded and the sample rate. Please remember that after the parameters have been changed, you must restart the measurements by clicking Stop and Play buttons sequentially. In this case, the previous measurement results will be saved in a separate tab in the «Sampled Data Representation» window.

Better to see once

Let's try to register the parameters of the power supply unit together. As an example, we record data about the amount of current consumed by your mobile phone when it is charged.

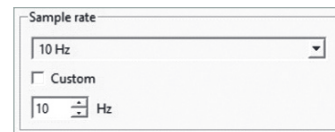

And, most importantly, let's see what the nature of this consumption is. First of all, we will select the sample rate- the frequency with which we will measure the current consumption value. Let it be 100 Hz. Use the dropdown list to select the desired value.

The next step is to choose the specific parameter to be monitored.

As we agreed at the beginning, we take a current consumption at 5V line.

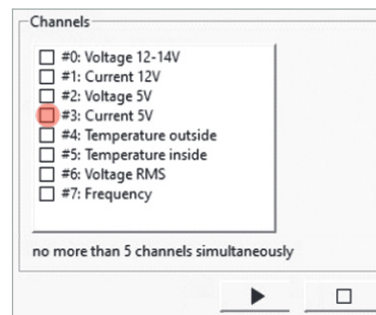

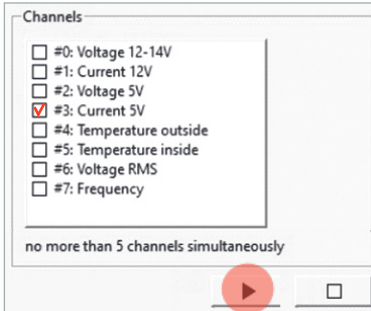

Click on the corresponding box in the Channels window.
We are almost done. All you have to do is to click the Play button.

Connect your phone to one of the USB outputs on the front panel. Immediately afterwards, you will see that the phone is consuming current. And the consumption is intermittent.

Very interesting.

It's time to examine the operation of your transceiver. To do this, just stop logging, select a measurement in the Channels window, for example, the value of current consumption along a 12V line, and start logging again.

To stop logging press the **Stop** button.

To see the accumulated data that is outside the screen, use the mouse to drag the time arrow in the desired direction.

Please remember that although the internal measurement circuits of the power supply have good accuracy, this device is not a laboratory meter. The main task of the logger is to show you the nature of the load that you connect to the power supply, as well as to identify short-term anomalies in operation of that load which cannot be noticed by the unaided eye.

By the way, if you need to measure currents less than 100 μA , use our other product - the REAMP laboratory logger.

Customizing device settings

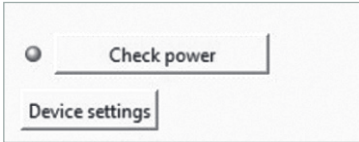

The REAMP companion software allows you to configure the device to make it convenient for you to work with it. To go to customization mode, click the Device Settings button.

In the settings window that opens you can set the following parameters:

- Whether to use a special gesture to quickly turn the device on or off, what to do after the mains failure, do Power 500 need to turn off if it is not used for a long time. As the power supply has a built-in ultra-precise real-time clock, you can set the power supply to turn on and off depending on the time of day.
- Whether it is necessary to show the clock on the device display when it is turned off.
- Which information screens should be shown and what information should be displayed on each of them. You can enable sequential display of all configured screens to see everything that is happening in the equipment connected to the power supply.

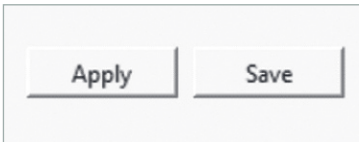
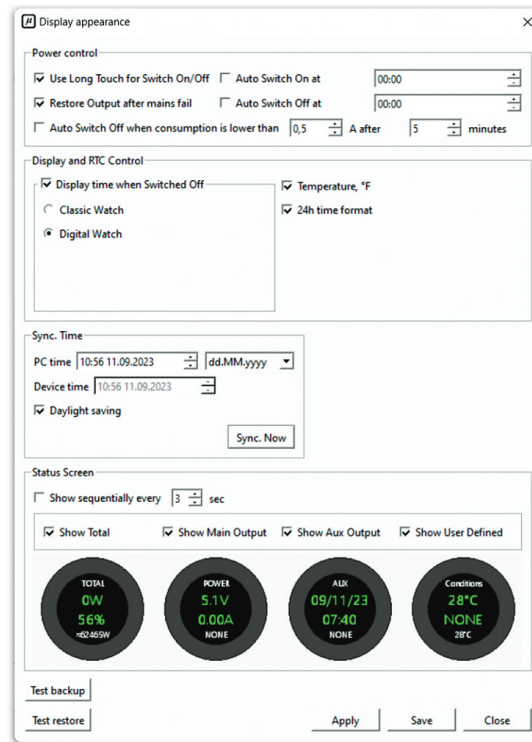

The new settings will take effect immediately after you click the Save or Apply button:

Remote control

To control the power supply from third-party software or via the Internet, you can use a special script written in Python.

first of all, download `hid_switch_power_on.py` and `hid_switch_power_off.py` files from Power 500 product page.

To switch Power 500 on just run `hid_switch_power_on.py` script. To turn off the power supply, use the `hid_switch_power_off.py` script.

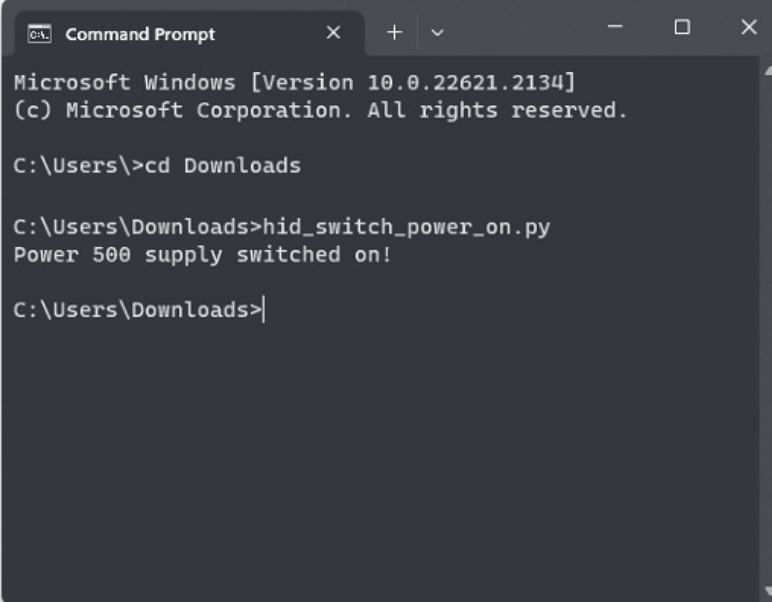

```
Command Prompt
Microsoft Windows [Version 10.0.22621.2134]
(c) Microsoft Corporation. All rights reserved.

C:\Users\>cd Downloads

C:\Users\Downloads>hid_switch_power_on.py
Power 500 supply switched on!

C:\Users\Downloads>|
```

Danger



NEVER ALLOW ANYONE, ESPECIALLY CHILDREN,
to push anything into the case holes or
to otherwise touch the power supply or its connecting cables.

There is grave danger of fatal electrical shock



Do not plug/unplug the power supply with wet hands.
It may easily cause electric shock.



Do not use the power supply where there may be flammable gas.
This may cause fire and explosion.

Caution



DO NOT OBSTRUCT AIR INTAKE or **EXHAUST** areas of the power supply.
Keep a minimum distance of 20cm (8 inches) clear of the rear panel air
exhaust opening.



Note that your grounding system may have to handle a current of more
than 15 Amperes. This requires an adequately sized and
well-maintained conductor of at least 4 mm² (AWG 11 or AWG 13).
If this is not the case at your operating location, you should make the
necessary changes using a licensed electrician.

Precautions

Caution



Do not undertake or perform any repair or adjustment of your power supply yourself, including any attempt to change hardware.

Doing so creates a potentially fatal shock hazard and may damage the power supply or equipment connected to it. RigExpert is not responsible for any such personal injury or equipment damage, whether caused by accident or as a result of good faith efforts of repair or adjustment.



Make sure that devices that are to be connected to the power supply meet its specifications, otherwise it may cause damage to the product.



Always hold the plug when plugging/unplugging the power supply.

Never unplug the power supply by pulling the cable as it may cause fire, shock and damage to the power supply.



Unplug the power supply immediately if anything unusual happens, such as smoke and or strange odors coming from it.

Contact the authorized service centers immediately for service.



Do not use the power supply for devices that require high current input at the start, such as motorized equipment and tools.

Do not charge the car battery. This may trigger the overcurrent protection circuit or even may cause damage to the power supply.

DECLARATION OF CONFORMITY
In accordance with EN ISO 17050-1: 2004

We,
Rig Expert Ukraine Ltd. of 2 Solomenska Ploscha, Kyiv, 03035, Ukraine
Declare under our sole responsibility that the product:

_____	Equipment	_____	Power Supplies	_____
_____	Brand name	_____	RigExpert	_____
_____	Model number	_____	Shackmaster™ Power 500	_____

to which this declaration relates, is in conformity with the following standards and / or other normative documents:

Reference No.:	Title:	Edition / Date:
IEC 61000-4-2	Testing and measurement techniques - Electrostatic discharge immunity test.	2009
IEC 61000-4-3	Testing and measurement techniques - Radiated, radio-frequency, electromagnetic field immunity test.	2006
BS EN/EN61000-4-4	Testing and measurement techniques - Electrical fast transient/burst immunity test	2010
BS EN/EN61000-4-5	Testing and measurement techniques - Surge immunity test	2017
BS EN/EN61000-4-6	Testing and measurement techniques - Immunity to conducted disturbances, induced by radio-frequency fields	2014
BS EN/EN61000-4-8	Testing and measurement techniques - Power frequency magnetic field immunity test	2010

We hereby declare that the above named product is in conformity to all the applicable essential requirements of directive 2004/108/EC (the EMC Directive).

/Ashot Andrieiev/ June 23,2023
CEO

For private households:

Information on Disposal for Users of WEEE

This symbol on the product(s) and / or accompanying documents means that used electrical and electronic equipment (WEEE) should not be mixed with general household waste.

For proper treatment, recovery and recycling, please take this product(s) to designated collection points where it will be accepted free of charge.

Alternatively, in some countries, you may be able to return your products to your local retailer upon purchase of an equivalent new product.

Disposing of this product correctly will help save valuable resources and prevent any potential negative effects on human health and the environment, which could otherwise arise from inappropriate waste handling. Please contact your local authority for further details of your nearest designated collection point. Penalties may be applicable for incorrect disposal of this waste, in accordance with your national legislation.

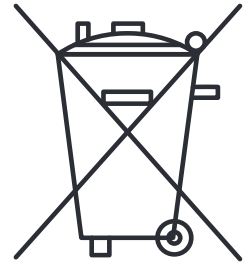

For professional users in the European Union

If you wish to discard electrical and electronic equipment (EEE), please contact your dealer or supplier for further information.

For disposal in countries outside of the European Union

This symbol is only valid in the European Union (EU). If you wish to discard this product, please contact your local authorities or dealer and ask for the correct method of disposal.

www.rigexpert.com

Copyright© 2020-2023 Rig Expert Ukraine Ltd.

«RigExpert» is a registered trademark of Rig Expert Ukraine Ltd.



Doc. date: 16-July-2023